

# CATÁLOGO 2023

ASOFER

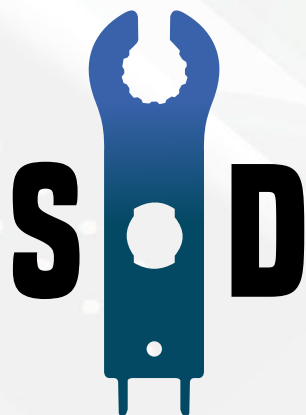



Santo Domingo, RD.



Cartagena

Medellín

Bogotá

4 sucursales estratégicas  
12 años de experiencia  
Marcas líderes  
Capacitaciones  
Rápida atención a clientes  
Soporte todo el año

**La solución perfecta para el instalador.**

# INDICE

PRODUCTOS POR CATEGORÍA

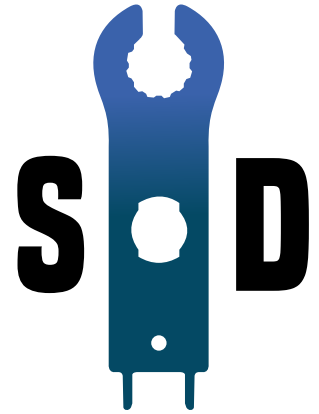

---

Nosotros	2
Microinversores	3
Inversores	7
Almacenamiento	37
Paneles solares	47
Calentadores de agua	55
Sistemas de montaje	58
Protecciones DC	63

## República Dominicana

🏠 Carretera Sánchez Km. 12 1/2, Santo Domingo, R.D.

## Colombia:

🏠 Cartagena: Km 9 Vía Mamonal, Bodegas G37-G38, Zona Franca La Candelaria

🏠 Bogotá: Km 1,9 vía Funza - Bodega 15 Parque Empresarial de Occidente

🏠 Medellín: Calle 82 Sur #47 F - 85 Sabaneta, Antioquia Colombia

☎ +1 (829) 206-8560

✉ gerencia@solardepot.do

🌐 [www.solardepot.do](http://www.solardepot.do)

# Nosotros

Somos una empresa con mas de 10 años de experiencia especializada en sistemas de energía solar fotovoltaica en México, brindaremos servicios y soluciones de eficiencia energética, ofreciéndoles a nuestros clientes únicamente productos de la más alta calidad comprometidos con el cuidado del medio ambiente y diseñados para durar en funcionamiento más de 25 años.

- Paneles solares desde 410 watts hasta 600 watts de marcas Premium Tier1.
- Micro-Inversores de alta gama.
- Inversores centrales de alta gama desde 3.6 kwp hasta 125 kwp.
- Sistemas de montaje especializados de alta resistencia para paneles solares.
- Equipo para Anclaje químico de ultima tecnología.
- Accesorios y protecciones de alta calidad para Instalaciones PV.
- Sistemas de monitoreo de generación y consumo del cliente.
- Equipos de independencia energética (Aislados e Híbridos).

## ¿Por qué SD?

Contamos con productos para el sector fotovoltaico de las marcas más reconocidas en la industria global. Tenemos ejecutivos capacitados para brindar una atención excepcional a todos nuestros clientes y aliados. Garantizamos la entrega inmediata en todas nuestras sucursales ubicadas en puntos estrategicos.

## Misión

Que nuestros servicios de distribución de equipos fotovoltaicos cumpla con las necesidades de nuestros clientes con calidad, eficiencia, respaldo, existencias e innovación; así como el máximo cuidado al Medio Ambiente.

## Visión

Ser caracterizados como el mayorista líder de energía solar fotovoltaica en Latinoamérica, agregando continuamente valor a nuestra marca, logrando acercar a más gente a la cultura y beneficios del desarrollo sustentable, y así conseguir un crecimiento continuo en el uso de energía solar, suministrada por nosotros.





# MICROINVERSORES HOYMILES MI-1500





## Model MI-1000 MI-1200 MI-1500

### Input Data (DC)

Commonly used module power (W)	200 ~ 310	240-380	300-470
Module compatibility	60-cell or 72-cell PV modules	60-cell or 72-cell PV modules	60-cell or 72-cell PV modules
Peak power MPPT voltage range (V)	27 ~ 48	32-48	36-48
Start-up voltage (V)	22	22	22
Operating voltage range (V)	16-60	16-60	16-60
Maximum input voltage (V)	60	60	60
Maximum input current (A)	4*10.5	4*10.5	4*11.5

### Output Data (AC)

Maximum continuous output power (W)	1000		1200		1500	
Maximum continuous output current (A)	4.17	4.81	5	5.33	6.25	7.21
Nominal output voltage/range (V)	240/211-264 <sup>1</sup>	208/183-228 <sup>1</sup>	240/211-264 <sup>1</sup>	208/183-228 <sup>1</sup>	240/211-264 <sup>1</sup>	208/183-228 <sup>1</sup>
Nominal frequency/range (V)	60/55-65 <sup>1</sup>		60/55-65 <sup>1</sup>		60/55-65 <sup>1</sup>	
Power factor	>0.99		>0.99		>0.99	
Total harmonic distortion	<3%		<3%		<3%	
Maximum units per branch <sup>2</sup>	5	5	4	4	3	3

### Efficiency

CEC peak efficiency	96.70%	96.70%	96.70%
CEC weighted efficiency	96.50%	96.50%	96.50%
Nominal MPPT efficiency	99.80%	99.80%	99.80%
Nighttime power consumption (mW)	<50	<50	<50

### Mechanical Data

Ambient temperature range (°C)	-40~+65
Dimensions (W×H×D mm)	280x176x33
Weight (kg)	3.75 (including 2.32m AC cable)
Enclosure rating	Outdoor-NEMA (IP67)
Cooling	Natural convection – No fans

### Features

Communication	2.4GHz Proprietary RF(Nordic)
Monitoring	Hoymiles monitoring system
Compliance	UL1741, IEEE1547, CSA C22.2 No. 107.1-16, FCC 15B, FCC 15C
PV Rapid Shutdown	Conforms with NEC-2014 and NEC-2017 Article 690.12 and CEC-2018 Sec 64-218 Rapid Shutdown of PV Systems

\*1 Nominal voltage/frequency range can be changed due to the requirements of local power department.

\*2 Refer to local requirements for exact number of microinverters per branch.

### High Reliability Based on World's Top Supplier Partners





**DTU - PRO**

**DTU STICK**



**DTU METER**

# MICROINVERSORES

## M-1000 / M-2000



Datos de Entrada DC	M-1000   M-2000	
Potencia de entrada recomendada (STC)	210~600 W	210~600 W
Voltaje máximo de entrada DC	60V	60V
Rango de voltaje en operación	20~60V	20~60V
Rango de voltage de MPPT	25~55V	25~55V
Corriente max de cortocircuito DC	16A	16A
Corriente max de entrada	12.5A x 2	12.5A x 4

General	M-1000   M-2000	
Dimensiones (H x W x D)	212.1 x 228.9 x 39.9 mm	
Longitud del cable de interconexión (m)	4m	
Peso	3.5 kg	
Recinto (Caja)	NEMA 6	
Temperatura Ambiente	-40~65°C, >45°C Antes de reducción	
Estilo de Instalación	Mural	
Comunicación Wi-Fi	Incluido	
Garantía Estándar	25 Años	
Refrigeración	Convección natural	

Datos de Salida AC	M-1000   M-2000	
Potencia nominal de salida	1000 W	2000 W
Potencia máxima de salida	1100 W	2200 W
Corriente nominal de salida	4.8A	9.6A
Corriente máxima de salida	5.1A	10.1A
Voltaje Nominal / Rango	208V/240V   176V~242V	
Frecuencia	50/60Hz	
Frecuencia / Rango extendido	45~55Hz/ 55~63Hz	
Factor de potencia	>0.99	
Unidades por cada cadena	4	3
Altitud máxima permitida	< 4000m	
Corriente máxima de retroalimentación del inversor al conjunto	0A	
Corriente máxima de fallo en la salida	10A	

Eficiencia	M-1000   M-2000	
Eficiencia ponderada CEC	95%	
Eficiencia máxima del inversor	96.5%	
Eficiencia del MPPT estático	99%	
Consumo de energía nocturno	50 mW = 0.05 W	

# INVERSOR CENTRAL MONOFÁSICO

## 7000W | 9000W

### KEY FEATURES



#### Enhance Solar System Output

Support high current PV modules with 12.5A operation current.



#### Max. Efficiency 98.1%

H6 Plus high efficient topology with Max. efficiency 98.1%, Europe 97.5%.



#### User Friendly

Light weight allows one person installation.  
Real-time monitoring with Cloud platform.  
Support one-click inverter configuration.  
Support remote parameter configuration & firmware update.



#### Higher Reliability

Integrated power module design.  
Integrated DC switch.  
Natural convection.  
IP65.

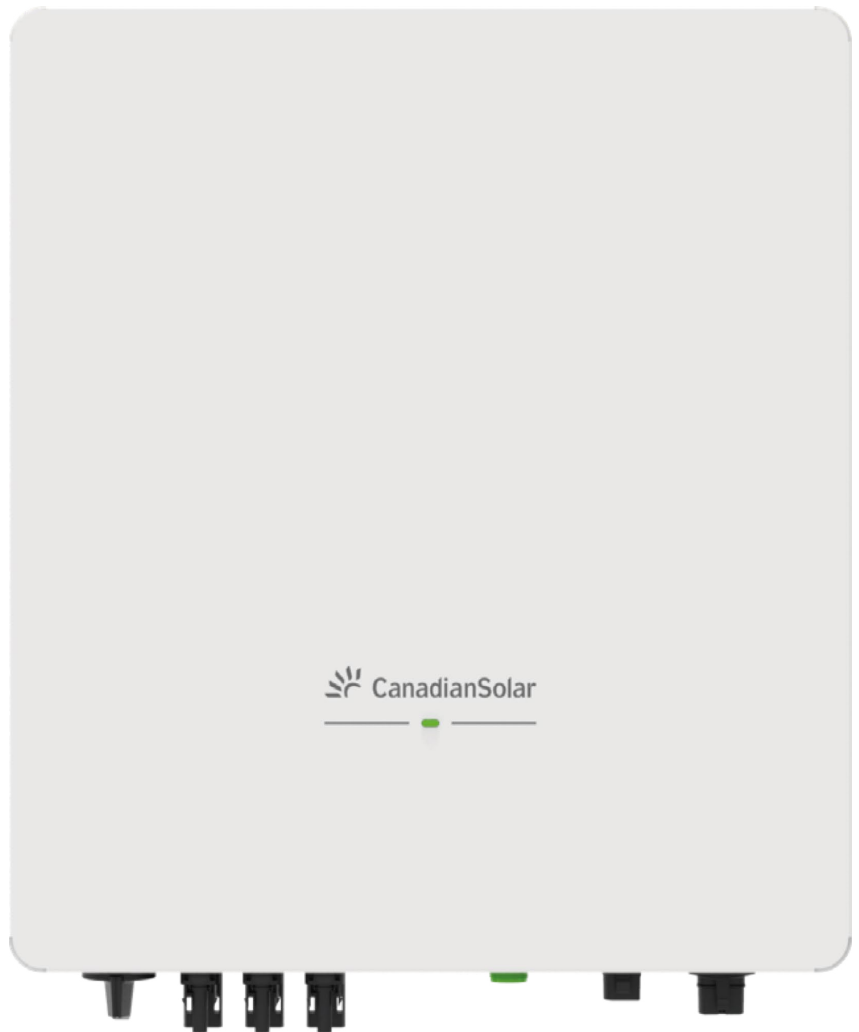

standard warranty, extention up to 10 years

SYSTEM TECHNICAL DATA			
MODEL NAME	CSI-7K-S22002-E	CSI-8K-S22002-E	CSI-9K-S22002-E
<b>DC INPUT</b>			
Max. PV Power (W)	9100	10400	11700
Max. DC Input Voltage (V)	600	600	600
Start-up DC Input Voltage (V)	120	120	120
MPPT Operating Voltage Range (V)	100 - 500	100 - 500	100 - 500
Rated Input Voltage (V)	360	360	360
Max. Input Current (A)	12.5 / 25	12.5 / 25	12.5 / 25
Max. Short-Circuit Current (A)	15 / 30	15 / 30	15 / 30
Number of MPP Trackers	2	2	2
Number of DC Inputs	1 / 2	1 / 2	1 / 2
<b>AC OUTPUT</b>			
Rated Output Power (W)	7000	8000	9000
Max. Output Power (W)	7700	8000	9000
AC Grid Connection Type	L / N / PE		
AC Nominal Voltage And Range (V)	220 / 230 / 240 (180 ~ 280)		
AC Nominal Frequency And Range (Hz)	50 / 60 (±5)		
Max. Output Current (A)	35	36.4	40.9
Power Factor (@Rated Output Power)	> 0.99		
Displacement Power Factor	0.8 leading to 0.8 lagging		
Total Harmonic Distortion (THDi)	< 3%		
<b>EFFICIENCY</b>			
Max. Efficiency	98.1 %	98.1 %	98.1 %
European Efficiency	97.5 %	97.5 %	97.5 %
MPPT Efficiency	99.9 %	99.9 %	99.9 %
<b>SAFETY &amp; PROTECTION</b>			
DC Switch	Integrated		
Anti-Islanding Protection	Integrated		
DC Reverse-Polarity Protection	Integrated		
Insulation Monitoring	Integrated		
AC Over Voltage Protection	Integrated		
AC Over Current Protection	Integrated		
AC Short-Circuit Protection	Integrated		
Residual Current Protection	Integrated		
Overvoltage Class	II (DC), III (AC)		
<b>GENERAL PARAMETERS</b>			
Dimensions (W*H*D, mm)	399 * 446* 192		
Net Weight (kg)	18.1		
Installation Method	Wall - mounted		
DC Connection Type	MC4 / H4		
AC Connection Type	Connector		
Communication Interfaces	RS485 / WiFi		
Display	LED Indicator		
Cooling	Natural Convection		
Protection Degree	IP65		
Operating Ambient Temperature Range (°C)	- 25 ~ 60 °C (> 45 °C, derating operation)		
Relative Humidity (Non-Condensing)	0% ~ 100%		
Max. Operating Altitude (m)	4000 m (> 3000 m, derating operation)		
Acoustic Noise Emission Level (dBA)	< 25		
Topology	Transformerless		
Night Power Consumption (W)	< 1		
Safety and EMC	IEC 62109-1/2, IEC 61000-6-1, IEC 61000-6-3		
Grid Connection Standard	IEC61727, IEC62116		

The specification and key features described in this datasheet may deviate slightly and are not guaranteed. Due to on-going innovation, research and product enhancement, Canadian Solar Inc. reserves the right to make any adjustment to the information described herein at any time without notice. Please always obtain the most recent version of the datasheet which shall be duly incorporated into the binding contract made by the parties governing all transactions related to the purchase and sale of the products described herein.

**CANADIAN SOLAR INC.**

545 Speedvale Avenue West, Guelph, Ontario N1K 1E6, Canada, [www.canadiansolar.com](http://www.canadiansolar.com)



## CPS SCA1~3.6KTL-S

Inversor Monofásico Chint Power

Alto Rendimiento durante su Completo  
Ciclo de Vida





Nombre del Modelo	CPS SCA1KTL-S	CPS SCA2KTL-S	CPS SCA2.5KTL-S	CPS SCA3KTL-S	CPS SCA3.6KTL-S
<b>Entrada de CC</b>					
Potencia Nominal de CC	1,150W	2,250W	2,800W	3,350W	4,000W
Tensión Máxima de CC	600Vcc				
Rango de Tensión del MPPT	90 - 580Vcc				
Tensión Nominal de CC	360Vcc				
Tensión de Arranque	90Vcc				
Tensión Mínima de CC	70Vcc				
Corriente Máxima de CC	11A				
Número de Entradas de CC por MPPT	1				
Número de MPPTs	1				
Interruptor de CC	Opcional				
<b>Salida de CA</b>					
Potencia Nominal de CA	1,000W	2,000W	2,500W	3,000W	3,600W
Potencia Máxima de CA	1,100VA	2,200VA	2,750VA	3,300VA	3,960VA
Corriente Nominal de CA	4.5A	9.1A	11.4A	13.6A	16.4A
Corriente Máxima de CA	4.8A	9.5A	11.9A	14.3A	17.2A
Tensión Nominal de CA / Rango	220V, 230V, 240V / 180 - 280V				
Frecuencia de Red / Rango	50 / 60 ± 5Hz				
Factor de Potencia (cosφ)	±0.8 (ajustable)				
Corriente THD	< 3%				
Tipo de Conexión de Red	Línea + Línea + Tierra de Protección				
<b>Eficiencia</b>					
Eficiencia Máxima	97.4%	97.4%	97.6%	97.6%	97.6%
Euroeficiencia	96.1%	96.8%	97.3%	97.3%	97.3%
Eficiencia del MPPT	> 99.5%				
<b>Protección</b>					
Protección Interna contra Sobretensión	Integrada				
Monitoreo de Aislamiento de CC	Integrado				
Monitoreo DCI	Integrado				
Monitoreo GFCI	Integrado				
Monitoreo de Red	Integrado				
Protección a la Corriente de Cortocircuito de CA	Integrada				
Protección Térmica	Integrada				
Monitoreo de Protección Anti-isla	AFD				
<b>Interfaz</b>					
Conexión de CA	Conector Enchufable				
Conexión de CC	MC4 / H4				
Pantalla LCD / LED	LED * 3 + APP (Bluetooth)				
Lenguaje	Inglés				
Comunicación	RS232 (Estándar) / Wi-Fi & GPRS & RS485 (Opcional)				
<b>Información General</b>					
Topología	Sin Transformador				
Consumo Nocturno	< 0.2W				
Consumo en Modo de Espera	6W				
Rango de Temperatura de Operación	-25°C a +60°C (45°C a 60°C con reducción)				
Método de Enfriamiento	Convección Natural				
Humedad Relativa	0 - 100%, Sin Condensación				
Altitud	4,000m (2,000m con reducción)				
Ruido	< 25dBA				
Protección de Ingreso	IP65				
Dimensiones (ancho*alto*profundo) [mm]	285 * 336 * 125				
Peso [kg]	8.8				
Garantía [años]	5 (Estándar) / 20 (Opcional)				
Certificaciones	IEC62109-1/2, IEC61000-6-1/2/3/4, IEC61727/62116, IEC61683				



## CPS SCA5~6KTL-SM

Inversor Monofásico Chint Power  
Alto Rendimiento durante su Completo  
Ciclo de Vida





Nombre del Modelo	CPS SCA3KTL-SM	CPS SCA4KTL-SM	CPS SCA5KTL-SM	CPS SCA6KTL-SM
<b>Entrada de CC</b>				
Potencia Nominal de CC	3,350W	4,450W	5,550W	6,050W
Tensión Máxima de CC	600Vcc			
Rango de Tensión de los MPPTs	90 - 580Vcc			
Tensión Nominal de CC	360Vcc			
Tensión de Arranque	90Vcc			
Tensión Mínima de CC	70Vcc			
Corriente Máxima de CC	11A			
Número de Entradas de CC por MPPT	1			
Número de MPPTs	2			
Interruptor de CC	Opcional			
<b>Salida de CA</b>				
Potencia Nominal de CA	3,000W	4,000W	5,000W	6,000W
Potencia Máxima de CA	3,300VA	4,400VA	5,500VA	6,000VA
Corriente Nominal de CA	13.6A	18.1A	22.7A	27.3A
Corriente Máxima de CA	14.3A	19.1A	23.8A	27.3A
Tensión Nominal de CA / Rango	220V, 230V, 240V / 180 - 280V			
Frecuencia de Red / Rango	50 / 60 ± 5Hz			
Factor de Potencia (cosφ)	±0.8 (ajustable)			
Corriente THD	< 3%			
Tipo de Conexión de Red	Línea + Línea + Tierra de Protección			
<b>Eficiencia</b>				
Eficiencia Máxima	97.6%	97.6%	97.8%	98.0%
Euroeficiencia	97.2%	97.3%	97.3%	97.4%
Eficiencia de los MPPTs	> 99.5%			
<b>Protección</b>				
Protección Interna contra Sobretensión	Integrada			
Monitoreo de Aislamiento de CC	Integrado			
Monitoreo DCI	Integrado			
Monitoreo GFCI	Integrado			
Monitoreo de Red	Integrado			
Protección a la Corriente de Cortocircuito de CA	Integrada			
Protección Térmica	Integrada			
Monitoreo de Protección Anti-isla	AFD			
<b>Interfaz</b>				
Conexión de CA	Conector Enchufable			
Conexión de CC	MC4 / H4			
Pantalla LCD / LED	LED * 3 + APP (Bluetooth)			
Lenguaje	Inglés			
Comunicación	RS232 (Estándar) / Wi-Fi & GPRS & RS485 (Opcional)			
<b>Información General</b>				
Topología	Sin Transformador			
Consumo Nocturno	< 0.2W			
Consumo en Modo de Espera	6W			
Rango de Temperatura de Operación	-25°C a +60°C (45°C a 60°C con reducción)			
Método de Enfriamiento	Convección Natural			
Humedad Relativa	0 - 100%, Sin Condensación			
Altitud	4,000m (2,000m con reducción)			
Ruido	< 25dBA			
Protección de Ingreso	IP65			
Dimensiones (ancho*alto*profundo) [mm]	335 * 426 * 125			
Peso [kg]	12.8			
Garantía [años]	5 (Estándar) / 20 (Opcional)			
Certificaciones	IEC62109-1/2, IEC61000-6-1/2/3/4, IEC61727/62116, IEC61683			



## 25KW 208V, 1000VDC STRING INVERTERS FOR NORTH AMERICA

### CPS SCA25KTL-D0/US-208

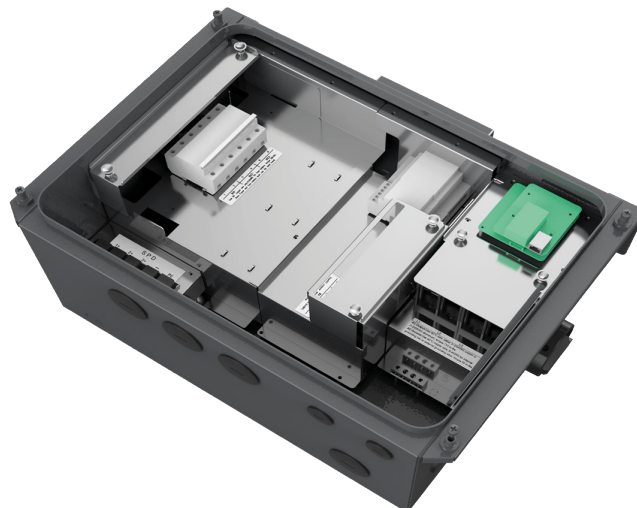

25KTL Rapid Shutdown Wire-box

Model Name	CPS SCA25KTL-DO/US-208
<b>DC Input</b>	
Max. PV Power	45kW (17kW per MPPT)
Max. DC Input Voltage	1000Vdc
Operating DC Input Voltage Range	200-950Vdc
Start-up DC Input Voltage / Power	330V / 80W
Number of MPP Trackers	3
MPPT Voltage Range @ PF>0.99	480-850Vdc
Max. PV Short-Circuit Current (Isc x 1.25)	135A (45A per MPPT)
Number of DC Inputs	6 inputs, 2 per MPPT
DC Disconnection Type	Load-rated DC switch
DC Surge Protection	Type II MOV, 2800V <sub>c</sub> , 20kA I <sub>TM</sub> (8/20 μS)
<b>AC Output</b>	
Rated AC Output Power @ PF>0.99	25kW
Max. AC Apparent Power (Selectable)	25kVA
Rated Output Voltage	208Vac
Output Voltage Range <sup>1</sup>	183 - 228Vac
Grid Connection Type	3Φ / PE / N (Neutral optional)
Max. AC Output Current @480Vac	69.5A
Rated Output Frequency	60Hz
Output Frequency Range <sup>1</sup>	57 - 63Hz
Power Factor	>0.99 (±0.8 adjustable)
Current THD @ Rated Load	<3%
Max. Fault Current Contribution (1 Cycle RMS)	64.1A (0.92 PU)
Max. OCPD Rating	110A
AC Disconnection Type	Load-break rated AC switch
AC Surge Protection	Type II MOV, 1240V <sub>c</sub> , 15kA I <sub>TM</sub> (8/20 μS)
<b>System and Performance</b>	
Topology	Transformerless
Max. Efficiency	97.0%
CEC Efficiency	96.5%
Stand-by / Night Consumption	<1W
<b>Environment</b>	
Enclosure Protection Degree	NEMA Type 4X
Cooling Method	Variable speed cooling fans
Operating Temperature Range <sup>2</sup>	-22°F to +140°F / - 30°C to +60°C
Non-Operating Temperature Range <sup>3</sup>	No low temp minimum to +158°F / +70°C maximum
Operating Humidity	0 to 100%
Operating Altitude	13,123.4ft / 4000m (derating from 9842.5ft / 3000m)
Audible Noise	<60dBA @ 1m and 25°C
<b>Display and Communication</b>	
User Interface and Display	LCD+LED
Inverter Monitoring	SunSpec, Modbus RS485
Site Level Monitoring	CPS Flex Gateway (1 per 32 inverters)
Modbus Data Mapping	CPS
Remote Diagnostics / FW Upgrade Functions	Standard / (with Flex Gateway)
<b>Mechanical</b>	
Dimensions (HxWxD)	39.4 x 23.6 x 10.24in. (1000 x 600 x 260mm)
Weight	Inverter: 123.5lbs/56kg; Wire-box: 33lbs/15kg
Mounting / Installation Angle <sup>4</sup>	15 to 90 degrees from horizontal (vertical or angled)
AC Termination	M8 Stud Type Terminal Block (Wire range: #6 - 3/0AWG CU/AL, Lugs not supplied)
DC Termination <sup>5</sup>	Screw Clamp, Neg. Busbar <sup>5</sup> Wire range: #14 - #6AWG CU
Fused String Inputs (2 per MPPT) <sup>6</sup>	20A fuses provided (Fuse values up to 30A acceptable)
<b>Safety</b>	
Certifications and Standards	UL1741-SA, UL1699B, UL1998, CSA-C22.2 NO.107.1-01, IEEE1547, FCC PART15
Selectable Grid Standard	IEEE 1547, CA Rule 21, ISO-NE, HECO
Smart-Grid Features	Volt-RideThru, Freq-RideThru, Ramp-Rate, Specified-PF, Volt-VAR, Freq-Watt, Volt-Watt
<b>Warranty</b>	
Standard	5 years
Extended Terms	Optional

1) The "Output Voltage Range" and "Output Frequency Range" may differ according to the specific grid standard.

2) Active Power Derating begins; at 45°C when PF=1 and MPPT  $\geq V_{min}$ , and at 50°C when PF=1 and MPPT  $V \geq 700V_{dc}$ .

3) See user manual for further requirements regarding non-operating conditions.

4) Shade Cover accessory required for installation angles of 75 degrees or less.

5) RSD wire-box only includes fuses/fuseholders on the positive polarity, compliant with NEC 2017, 690.9 (C).

6) Fuse values above 20A have additional spacing requirements or require the use of the Y-Comb Terminal Block. See user manual for details.

# CPS SCA30~36KTL-T/SA (208/220/240)



Inversor de Cadena Chint Power  
Alto Rendimiento durante su Ciclo de Vida Completo



## Baja Inversión

Esta serie de inversores de cadena trifásicos no solamente son productos diversificados que proporcionan un interruptor de CC integrado, una caja combinadora de CC integrada, protección estándar contra rayos de clase II, tarjeta de detección de cadena opcional, módulo de protección PID y comunicación inalámbrica GPRS/Wi-Fi/Ethernet/RS485, lo cual puede satisfacer los requisitos de diferentes clientes, a la vez que también puede soportar 10% de sobrecarga nominal y brinda un diseño sin pantalla, logrando disminuir eficientemente la inversión inicial del sistema.

## Grandes Beneficios

Los inversores de cadena trifásicos Chint Power pueden brindar una eficiencia máxima de 98.8%, una Euroeficiencia de 98.4%, eficiencia de los MPPTs de 99.5%, una topología de diseño avanzada y opciones de dispositivos internacionales conocidos, los cuales pueden garantizar los beneficios del Ciclo de Vida Completo.

## Garantía de Mantenimiento

Los inversores de cadena trifásicos Chint Power pueden brindar una garantía estándar por 5 años, una garantía extendida opcional por 10-25 años y una plataforma de operación inteligente, la cual puede garantizar de manera eficiente el mantenimiento del Ciclo de Vida Completo.

Nombre del Modelo	CPS SCA30KTL-T/SA	CPS SCA36KTL-T/SA		
<b>Entrada de CC</b>				
Potencia Máxima de CC	36kW	42kW		
Tensión Máxima de CC	800Vcc	800Vcc		
Rango de Tensión de los MPPTs	200-750Vcc			
Rango de Tensión MPPT (Carga Completa)	300 - 680Vcc	300-680Vcc		
Tensión de Arranque	250Vcc			
Número de MPPTs/Max. Número de Conjuntos de Conexión de CC	4/3+3+2+2	4/3+3+3+3		
Corriente Máxima de CC	110A (33/33/22/22)	132A (33/33/33/33)		
Tipo de Desconexión de CC	Interruptor Integrado			
<b>Salida de CA</b>				
Potencia Nominal de CA	208Vca	27.5kW	208Vca	32.5kW
	220Vca	29kW	220Vca	34.5kW
	240Vca	31.5kW	240Vca	37.5kW
Potencia Máxima de CA	33kVA		40kVA	
Tensión Nominal de CA	208V/220V/240Vca			
Rango de Tensión de CA*	150V-300Vca(ajustable)			
Tipo de Conexión a la Red	3Φ / N(Opcional) / PE			
Corriente Máxima de CA	83A		92A	
Frecuencia Nominal	50Hz/60Hz			
Rango de Frecuencia de Red*	45Hz-55Hz/55Hz-65Hz			
Factor de Potencia (cosφ)	±0.8 (ajustable)			
Corriente THD	< 3%			
Tipo de Desconexión de CA	-			
<b>Información del Sistema</b>				
Topología	Sin Transformador			
Eficiencia Máxima	98.80%		98.80%	
Euroeficiencia	98.40%		98.40%	
Consumo en Modo Espera / Nocturno	< 20W / < 1W			
<b>Información Ambiental</b>				
Protección de Ingreso	IP65			
Método de Enfriamiento	Enfriamiento por Ventilador			
Rango de Temperatura de Operación	-25°C - +60°C			
Humedad Ambiental	0 - 100%			
Altitud	4000m			
<b>Visualización y Comunicación</b>				
Pantalla	Bluetooth & APP +LED, LCD(Opcional)			
Comunicación	RS485, WiFi(Opcional), GPRS(Opcional), Ethernet(Opcional)			
<b>Características Mecánicas</b>				
Dimensiones (ancho x alto x profundo) [mm]	855 x 565 x 275			
Peso [kg]	67			
<b>Seguridad</b>				
Certificaciones	LVD:2006/95/EC EMC:2004/108/EC,IEC/EN 62109-1:2010,IEC/EN 62109-2: 2011; IEC/EN61000-6-2:2005, IEC/EN61000-6-3:2007,NB/T 320004-2014;GT/T19964-2012			

\* El "Rango de Tensión de Salida" y el "Rango de Frecuencia de Salida" pueden variar según los códigos de red específicos.



**Inversor CPS: SCA 50kW.  
60kW KTL-DO/US-480**



**Caja de Cableado  
Estándar  
de 50/60kW**



**Caja de Cableado  
"Rapid Shutdown"**



Nombre del modelo	CPS SCA50KTL-DO/US-480	CPS SCA60KTL-DO/US-480
<b>Entrada de CC</b>		
Potencia fotovoltaica máxima	90kW (33kW por MPPT)	
Tensión máxima de entrada de CC	1000Vcc	
Rango operativo de tensión de entrada de CC	200-950Vcc	
Tensión/Potencia de arranque de entrada de CC	330V / 80W	
Número de MPPTs	3	
Rango de tensión de los MPPTs @ PF>0.99 <sup>1</sup>	480-850Vcc	540-850Vcc
Corriente máxima de corto circuito fotovoltaica (Isc x 1.25)	204A (68A por MPPT)	
Número de entradas de CC	15 entradas, 5 por MPPT	
Tipo de desconexión de CC	Interruptor de carga nominal de CC	
Protección contra sobretensiones de CC	Tipo II MOV, 2,800V <sub>CC</sub> , 20kA I <sub>TM</sub> (8/20µS)	
<b>Salida de CA</b>		
Potencia nominal de salida de CA @ F P>0.99 a ±0.91 <sup>2</sup>	50kW	60kW
Potencia máxima aparente de CA (seleccionable)	50/55kVA	60/66kVA
Tensión nominal de salida	480Vca	
Rango de tensión de salida <sup>3</sup>	422 - 528Vca	
Tipo de conexión de red	3Ø/ PE/ N (Neutro opcional)	
Corriente máxima de salida de CA @ 480Vca	60.2/66.2A	72.2/79.4A
Frecuencia nominal de salida	60Hz	
Rango de frecuencia de salida <sup>3</sup>	57 - 63Hz	
Factor de potencia	>0.99 (±0.8 ajustable)	
Distorsión armónica total de corriente @ carga nominal	<3%	
Contribución máxima de corriente de falla (1 ciclo RMS)	64.1A	
Máxima capacidad del dispositivo de protección contra sobrecorriente	110A	125A
Tipo de desconexión de CA	Interruptor de carga nominal de CA	
Protección contra sobretensiones de CA	Tipo II MOV, 1,240V <sub>CA</sub> , 15kA I <sub>TM</sub> (8/20µS)	
<b>Sistema y rendimiento</b>		
Topología	Sin transformador	
Eficiencia máxima	98.8%	
Eficiencia CEC	98.5%	
Consumo de energía en Modo Espera / Nocturno	<1W	
<b>Medio ambiente</b>		
Clasificación de protección de la carcasa	NEMA Tipo 4X (IP66)	
Método de enfriamiento	Ventiladores de enfriamiento de velocidad variable	
Rango de temperatura de operación <sup>4</sup>	-22°F a +140°F / - 30°C a +60°C <sup>4</sup>	
Rango de temperatura de no operación <sup>5</sup>	Sin temperatura mínima hasta +158°F / +70°C máxima <sup>5</sup>	
Humedad de funcionamiento	0 a 100%	
Altitud de funcionamiento	13,123 4ft/ 4,000m (reducción de potencia desde 9,842.5ft/3,000m)	
Ruido audible	<60dBA @ 1m y 25°C	
<b>Pantalla y comunicación</b>		
Interfaz de usuario y pantalla	LCD+LED	
Monitoreo del inversor	Modbus RS485	
Monitoreo del nivel de sitio	Flex Gateway de CPS (1 por 32 inversores)	
Mapeo de datos Modbus	CPS	
Diagnósticos y actualizaciones de Firmware remotos	Estándar con el Flex Gateway (opcional)	
<b>Características mecánicas</b>		
Dimensiones (alto x ancho x profundo)	39.4 x 23.6 x 10.24 pulgadas (1,000x 600x 260mm)	
Peso	Inversor: 123.5lbs/56kg; Caja de Cableado: 33lbs/15kg	
Ángulo de montaje/instalación <sup>6</sup>	0 a 90 grados desde la horizontal (instalación vertical, inclinada o plana) <sup>6</sup>	
Borne de CA <sup>7</sup>	Bloque terminal tipo roscado M8 (rango de cable: #6 - 3/OAWG CU/AL <sup>7</sup> , terminales no incluidas)	
Borne de CC	Portafusibles de pinza de tornillo (rango de cable: #14 - #6AWG CU), opcional H4 (Amphenol)	
Entradas de cadenas con fusibles (5 por MPPT) <sup>8</sup>	Fusibles de 15A incluidos (valores aceptables de hasta 30A) <sup>8</sup>	
<b>Seguridad</b>		
Certificaciones y normas	UL1741SA-2016, UL1699B, CSA-C22.2 NO.107.1-01, IEEE1547a-2014; FCC PARTE15	
Norma de red seleccionable y SRD	IEEE1547a-2014, Regla 21 de California	
Características de red inteligente	Tensión y Frecuencia Ride-Through, Arranque Suave, Volt-Var, Frecuencia-Watt, Volt-Watt	
<b>Garantía</b>		
Estándar	5 años	
Garantía ampliada	Consultar a fábrica	

1) Consulte el manual de usuario para obtener más información sobre el rango de tensión de los MPPTs cuando el Factor de Potencia se establezca como menor a 1.  
 2) La Reducción de Potencia Activa comienza @ F P=±0.91 a ±0.8 cuando la Máxima Potencia Aparente se establece en 55 o 66kVA.  
 3) El "Rango de Tensión de Salida" y el "Rango de Frecuencia de Salida" pueden variar de acuerdo con la norma estándar específica de la red.  
 4) La Reducción de Potencia Activa comienza @ 40°C cuando FP=±0.9 y MPPT ≥ V<sub>min</sub>, @ 45°C cuando FP=1 y MPPT ≥ V<sub>min</sub>, y @ 50°C cuando FP=1 y MPPT V<sub>2</sub>≥700Vcc  
 5) Consulte el manual de usuario para obtener otros requisitos adicionales relacionados con las condiciones de no operación.  
 6) Se requiere el accesorio de cubierta de sombra para instalaciones con ángulos de 75 grados o menores.  
 7) AL requiere terminal de compresión bimetálica o adaptador bimetálico.  
 8) Fusibles mayores a 20A tienen requerimientos adicionales de espacio o requieren el uso del adaptador Y-comb. Consulte el manual de usuario para mayores detalles.





## INVERSOR CPS: SCH 100KW, 125KW KTL-D0/US-600



**Caja de Cableado  
de 100/125kW  
Diseño Estándar**



**Caja de Cableado  
de 100/125kW  
Diseño Centralizado**



Nombre del modelo	CPS SC H100KTL-D0/US-600	CPS SC H125KTL-D0/US-600
<b>Entrada de CC</b>		
Potencia máxima fotovoltaica		187.5kW
Tensión máxima de entrada de CC		1500V
Rango operativo de tensión de entrada de CC		860-1450Vcc
Tensión / Potencia de arranque de entrada de CC		900V / 250W
Número de MPPTs		1
Rango de tensión del MPPT		870-1,300Vcc
Corriente máxima de corto circuito fotovoltaica (Isc x 1.25)		275A
Número de entradas de CC	20 circuitos fuente fotovoltaicos, pos. & neg. con fusible (Caja de Cableado Estándar) 1 circuito fotovoltaico de salida, 1-2 terminaciones por polo, sin fusible (Caja de Cableado Centralizada)	
Tipo de desconexión de CC	Interruptor de carga nominal de CC	
Protección contra sobretensiones de CC	Tipo II MOV, Up=2.5kV, In=20kA (8/20us)	
<b>Salida de CA</b>		
Potencia nominal de salida de CA	100kW	125kW
Potencia máxima de salida de CA <sup>1</sup>	100kVA (111KVA @ FP>0.9)	125kVA (132KVA @ FP>0.95)
Tensión nominal de salida		600Vca
Rango de tensión de salida <sup>2</sup>		528-660Vca
Tipo de conexión de red <sup>3</sup>		3Φ / PE / N (Neutro opcional)
Corriente nominal de salida de CA @ 600Vca	96.2/106.8A	120.3/127.0A
Frecuencia nominal de salida		60Hz
Rango de frecuencia de salida <sup>2</sup>		57-63Hz
Factor de potencia	>0.99 (±0.8 ajustable)	>0.99 (±0.8 ajustable)
Distorsión armónica total de corriente		<3%
Tipo de desconexión de CA	Interruptor de carga nominal de CA (solamente Caja de Cableado Estándar)	
Protección contra sobretensiones de CA	Tipo II MOV, Up=2.5kV, In=20kA(8/20us)	
<b>Sistema y rendimiento</b>		
Topología	Sin transformador	
Eficiencia máxima	99.1%	
Eficiencia CEC	98.5%	
Consumo de energía en Modo Espera / Nocturno	<2W	
<b>Medio ambiente</b>		
Clasificación de protección de la carcasa	NEMA Tipo 4X (IP66)	
Método de enfriamiento	Ventiladores de enfriamiento de velocidad variable	
Rango de temperatura de operación	-22°F a +140°F / -30°C a +60°C (reducción de potencia desde +113°F / +45°C)	
Rango de temperatura de no operación <sup>4</sup>	-40°F a +158°F / -40°C a +70°C máxima <sup>4</sup>	
Humedad de funcionamiento	0-100%	
Altitud de funcionamiento	8,202ft / 2,500m (sin reducción de potencia)	
Ruido audible	<65dBA@1m y 25°C	
<b>Pantalla y comunicación</b>		
Interfaz de usuario y pantalla	Indicadores LED, WiFi + APP	
Monitoreo del inversor	Modbus RS485, Opción de PLC (solamente Caja de Cableado Estándar)	
Monitoreo del nivel de sitio	Flex Gateway de CPS (1 por 32 inversores)	
Mapeo de datos Modbus	SunSpec/CPS	
Diagnósticos y actualizaciones de Firmware remotos	Estándar	
<b>Características mecánicas</b>		
Dimensiones (alto x ancho x profundo)	45.28x24.25x9.84 pulgadas (1,150x616x250mm) con Caja de Cableado Estándar 39.37x24.25x9.84 pulgadas (1,000x616x250mm) con Caja de Cableado Centralizada	
Peso	Inversor: 121lbs / 55kg;Caja de Cableado: 55lbs / 25kg (Caja de Cableado Estándar); 33lbs / 15kg (Caja de Cableado Centralizada)	
Ángulo de montaje / instalación	15 a 90 grados desde la horizontal (instalación vertical o inclinada)	
Bornes de CA <sup>5</sup>	Bloque terminal tipo roscado M8 (rango de cable: #6 - 3/0AWG CU/AL <sup>5</sup> , terminales no incluidas)	
Bornes de CC	Portafusibles de pinza de tornillo (rango de cable: #12 - #6AWG CU) - Caja de Cableado Estándar Barra colectora, M8 PEMserts (rango de cable: #1AWG-250kcmil CU/AL, terminales no incluidas) - Caja de Cableado Centralizada	
Entradas de cadenas con fusibles	Fusibles de 20A incluidos (fusibles con valores de 15 o 20A son permitidos)	
<b>Seguridad</b>		
Seguridad y norma EMC	UL1741 -SA-2016, UL1699B, CSA-C22.2 NO.107.1-01, IEEE1547a-2014; FCC PARTE15	
Norma de red	IEEE 1547a-2014, Regla 21 de California	
Características de red inteligente	Tensión y Frecuencia Ride-Through, Arranque-Suave, Volt-Var, Frecuencia - Watt	
<b>Garantía</b>		
Estándar	5 años	
Garantía ampliada	Consultar a fábrica	

1) La clasificación de "Potencia Máxima Aparente de CA" es válida dentro del rango de tensión del MPPT y el rango de temperatura desde -30°C a +40°C (-22°F a +104°F) para 100kW FP>0.9 y 125kW FP>0.95

2) El "Rango de Tensión de Salida" y el "Rango de Frecuencia de Salida" pueden variar de acuerdo con la norma estándar específica de la red.

3) Conexión en estrella con puesta a tierra, conexión en delta puede no ser aterrizada en esquina.

4) Consulte el manual de usuario para obtener otros requisitos adicionales relacionados con las condiciones de no operación.

5) AL requiere terminal de compresión bimetalica o adaptador bimetalico.

# Ex9N-G 3-15kW

## Three Phase On-Grid Solar Inverter



### Efficient Higher revenue

- 2MPP Trackers, high single circuit tracking accuracy, fast dynamic response.
- 160% DC Input Oversizing
- Wide MPPT voltage range: 180V-1000V
- Compatible with high power modules



### Intelligent Simple O&M

- Smart I-V Curve Diagnosis Function: locate PV string faults accurately and automatically detect faults
- Intelligent Fault Detection: ac-side voltage and current waveforms real-time recorded, fast fault location
- Support RS485/USB (WiFi/GPRS/Ethernet optional): remote monitoring and operation via PC or mobile phones



### Reliable Worry free

- IP66 Protection degree: support outdoor installation
- DC & AC Type II SPD: prevent lightning damage
- AFCI Function (Optional): when an arc-fault is detected the inverter immediately stops operation

	Ex9N-G-3kW	Ex9N-G-4kW	Ex9N-G-5kW	Ex9N-G-6kW	Ex9N-G-8kW	Ex9N-G-9kW	Ex9N-G-10kW	Ex9N-G-11W	Ex9N-G-12kW	Ex9N-G-15W	
<b>Input (DC)</b>											
Max. Input Power	4.8kW	6.4kW	8kW	9.6kW	12.8kW	14.4kW	16kW	17.6kW	19.2kW	24kW	
Max. Input Voltage	1100V										
Start Voltage	160V										
Rated Input Voltage	600V										
Full-load MPP Voltage Range	250V ~ 850V			320V ~ 850V		400V ~ 850V		450V ~ 850V		480V ~ 850V	500V ~ 850V
MPPT Voltage Range	180V ~ 1000V										
Number of MPP Trackers	2										
Number of String per MPPT	1 / 1									1 / 2	
Max. Current per MPPT	14A / 14A									14A / 28A	
Max. Short Circuit Current per MPPT	18A / 18A									18A / 36A	
<b>Output (AC)</b>											
Max. Output Current	4.8A	6.4A	8A	9.6A	12.8A	14.4A	15.9A	17.5A	19.1A	23.9A	
Rated Output Power	3kW	4kW	5kW	6kW	8kW	9kW	10kW	11kW	12kW	15kW	
Max. Output Power	3.3kVA	4.4kVA	5.5kVA	6.6kVA	8.8kVA	9.9kVA	11kVA	12.1kVA	13.2kVA	16.5kVA	
Rated Grid Frequency	50Hz / 60Hz										
Rated Grid Voltage	230Vac / 400Vac, 3L / N / PE										
Power Factor	>0.99 (0.8 leading~0.8 lagging)										
THDi	<3% (Rated Power)										
<b>Efficiency</b>											
Max. Efficiency	98.40%				98.70%						
European Efficiency	98.30%				98.50%						
MPPT Efficiency	99.90%										
<b>Protection</b>											
DC reverse polarity protection	Yes										
Anti-islanding protection	Yes										
AC short circuit protection	Yes										
Residual current monitoring unit	Yes										
Insulation resistance monitoring	Yes										
Ground fault monitoring	Yes										
Grid monitoring	Yes										
Surge protection	Type II										
AFCI protection	Optional										
<b>Communication</b>											
Display	LED / LCD (Optional)										
Communication	Standard: RS485 / USB Optional: WiFi / GPRS / Ethernet										
<b>Standard Compliance</b>											
Grid Connection Standards	IEC 61727, IEC 62116, IEC 60068, IEC 61683, VDE-AR-N 4110:2018, VDE-AR-N 4105:2018, VDE-AR-N 4120:2018, EN 50549, AS/NZS 4777.2:2020, CEI 0-21, VDE 0126-1-1/A1 VFR 2014, UTE C15-712-1:2013, DEWA DRRG, NRS 097-2-1, MEA/PEA, C10/11, G98/G99										
Safety / EMC	IEC 62109-1:2010, IEC 62109-2:2011, EN 61000-6-2:2005, EN 61000-6-3:2007/A1:2011										
<b>General Data</b>											
Dimensions (W x H x D)	481 x 395 x 195 mm										
Weight	12kg				13.5kg						
Operating Temperature Range	-30° C ~ +60° C										
Cooling Method	Natural									Smart Cooling	
Protection Degree	IP66										
Max. Operating Altitude	4000m										
Relative Humidity	0 ~ 100%										
Topology	Transformerless										
Night Power Consumption	<1W										

## Ex9N-G 15-25kW

### Three Phase On-Grid Solar Inverter



#### Efficient Higher revenue

- 2 MPP Trackers, high single circuit tracking accuracy, fast dynamic response
- 160% DC Input Oversizing
- Maximum efficiency 98.4%. Wide MPPT voltage range: 200V-1000V
- Compatible with high power modules.



#### Intelligent Simple O&M

- Smart I-V Curve Diagnosis Function: locate PV string faults accurately and automatically detect faults
- Intelligent Fault Detection: ac-side voltage and current waveforms real-time recorded, fast fault location
- Support RS485/USB (WiFi/GPRS/Ethernet optional): remote monitoring and operation via PC or mobile phones



#### Reliable Worry free

- IP66 Protection degree: support outdoor installation
- DC & AC Type II SPD: prevent lightning damage
- AFCI Function (Optional): when an arc-fault is detected the inverter immediately stops operation

	Ex9N-G-15kW	Ex9N-G-17kW	Ex9N-G-20kW	Ex9N-G-22kW	Ex9N-G-25kW
<b>Input (DC)</b>					
Max. Input Power	24kW	27.2kW	32kW	35.2kW	40kW
Max. Input Voltage	1100V				
Start Voltage	250V				
Rated Input Voltage	600V				
Full-load MPP Voltage Range	480V ~ 800V		520V ~ 800V		560V ~ 800V
MPPT Voltage Range	200V ~ 1000V				
Number of MPP Trackers	2				
Number of string per MPPT	2 / 2			2 / 3	
Max. Current per MPPT	26A			26A / 39A	
Max. Short Circuit Current per MPPT	32A			32A / 48A	
<b>Output (AC)</b>					
Max. Output Current	24.1A	27.2A	32.1A	35.3A	39.8A
Rated Output Power	15kW	17kW	20kW	22kW	25kW
Max. Output Power	16.6kVA	18.8kVA	22.2kVA	24.4kVA	27.5kVA
Rated Grid Frequency	50Hz / 60Hz				
Rated Grid Voltage	230Vac / 400Vac, 3L / N / PE				
Power Factor	>0.99 (0.8 leading~0.8 lagging)				
THDi	<3% (Rated Power)				
<b>Efficiency</b>					
Max. Efficiency	98.40%				
European Efficiency	98.00%				
MPPT Efficiency	99.90%				
<b>Protection</b>					
DC reverse polarity protection	Yes				
Anti-islanding protection	Yes				
AC short circuit protection	Yes				
Residual current monitoring unit	Yes				
Insulation resistance monitoring	Yes				
Ground fault monitoring	Yes				
Grid monitoring	Yes				
PV string monitoring	Yes				
Surge protection	Type II				
AFCI protection	Optional				
<b>Communication</b>					
Display	LED / LCD / WIFI+APP				
Communication	Standard: RS485 / USB Optional: WIFI / GPRS / Ethernet				
<b>Standard Compliance</b>					
Grid Connection Standards	IEC 61727, IEC 62116, IEC 60068, IEC 61683, VDE-AR-N 4110:2018, VDE-AR-N 4105:2018, VDE-AR-N 4120:2018, EN 50549, AS/NZS 4777.2:2020, CEI 0-21, VDE 0126-1-1/A1 VFR 2014, UTE C15-712-1:2013, DEWA DRRG, NRS 097-2-1, MEA/PEA, C10/11, G98/G99				
Safety / EMC	IEC 62109-1:2010, IEC 62109-2:2011, EN 61000-6-2:2005, EN 61000-6-3:2007/A1:2011				
<b>General Data</b>					
Dimensions (W x H x D)	534 x 440 x 220 mm				
Weight	24kg				
Operating Temperature Range	-30° C ~ +60° C				
Cooling Method	Smart Cooling				
Protection Degree	IP66				
Max. Operating Altitude	4000m				
Relative Humidity	0 ~ 100%				
Topology	Transformerless				
Night Power Consumption	<1W				

## Ex9N-G 25-40kW

### Three Phase On-Grid Solar Inverter



#### Efficient Higher revenue

- 3-4 MPP Trackers, high single circuit tracking accuracy, fast dynamic response
- 160% DC Input Oversizing
- Maximum efficiency of 98.6%. Wide MPPT voltage range: 200V-1000V
- Compatible with high power modules



#### Intelligent Simple O&M

- Smart I-V Curve Diagnosis Function: locate PV string faults accurately and automatically detect faults
- Intelligent Fault Detection: ac-side voltage and current waveforms real-time recorded, fast fault location
- Support RS485/USB (WiFi/GPRS/Ethernet optional): remote monitoring and operation via PC or mobile phones



#### Reliable Worry free

- IP66 Protection degree: support outdoor installation
- DC & AC Type II SPD: prevent lightning damage
- AFCI Function (Optional): when an arc-fault is detected the inverter immediately stops operation

	Ex9N-G-25kW	Ex9N-G-30kW	Ex9N-G-33kW	Ex9N-G-36kW	Ex9N-G-40kW
<b>Input (DC)</b>					
Max. Input Power	40kW	48kW	52.8kW	57.6kW	64kW
Max. Input Voltage	1100V				
Start Voltage	250V				
Rated Input Voltage	600V				
Full-load MPP Voltage Range	450V ~ 800V	500V ~ 800V			
MPPT Voltage Range	200V ~ 1000V				
Number of MPP Trackers / String per MPPT	3/2			4/2	
Max. Current per MPPT	26A				
Max. Short Circuit Current per MPPT	32A				
<b>Output (AC)</b>					
Max. Output Current	40.1A	48.3A	53A	57.8A	64.3A
Rated Output Power	25kW	30kW	33kW	36kW	40kW
Max. Output Power	27.7kVA	33.3kVA	36.6kVA	39.6kVA	44kVA
Rated Grid Frequency	50Hz / 60Hz				
Rated Grid Voltage	230Vac / 400Vac, 3L / N / PE				
Power Factor	>0.99 (0.8 leading~0.8 lagging)				
THDi	<3% (Rated Power)				
<b>Efficiency</b>					
Max. Efficiency	98.60%				
European Efficiency	98.50%				
MPPT Efficiency	99.90%				
<b>Protection</b>					
DC reverse polarity protection	Yes				
Anti-islanding protection	Yes				
AC short circuit protection	Yes				
Residual current monitoring unit	Yes				
Insulation resistance monitoring	Yes				
Ground fault monitoring	Yes				
Grid monitoring	Yes				
PV string monitoring	Yes				
Surge protection	Type II				
AFCI protection	Optional				
<b>Communication</b>					
Display	LED / LCD / WIFI+APP				
Communication	Standard: RS485/ USB Optional: WIFI / GPRS / Ethernet				
<b>Standard Compliance</b>					
Grid Connection Standards	IEC 61727, IEC 62116, IEC 60068, IEC 61683, VDE-AR-N 4110:2018, VDE-AR-N 4105:2018, VDE-AR-N 4120:2018, EN 50549, AS/NZS 4777.2:2020, CEI 0-21, VDE 0126-1-1/A1 VFR 2014, UTE C15-712-1:2013, DEWA DRRG, NRS 097-2-1, MEA/PEA, C10/11, G98/G99				
Safety / EMC	IEC 62109-1:2010, IEC 62109-2:2011, EN 61000-6-2:2005, EN 61000-6-3:2007/A1:2011				
<b>General Data</b>					
Dimensions (W x H x D)	600 x 430 x 230 mm				
Weight	30kg			32kg	
Operating Temperature Range	-30° C ~ +60° C				
Cooling Method	Smart Cooling				
Protection Degree	IP66				
Max. Operating Altitude	4000m				
Relative Humidity	0 ~ 100%				
Topology	Transformerless				
Night Power Consumption	<1W				

# Ex9N-G 50-70kW

Three Phase On-Grid Solar Inverter



**Efficient  
Higher revenue**

- 4 MPP Trackers, high single circuit tracking accuracy, fast dynamic response and higher power generation
- 160% DC Input Oversizing
- Wide MPPT voltage range: 200V-1000V
- Compatible with high power modules



**Intelligent  
Simple O&M**

- Smart I-V Curve Diagnosis Function: locate PV string faults accurately and automatically detect faults
- Intelligent Fault Detection: ac-side voltage and current waveforms real-time recorded, fast fault location
- Support RS485/USB (WiFi/GPRS/Ethernet optional): remote monitoring and operation via PC or mobile phones



**Reliable  
Worry free**

- IP66 Protection degree: support outdoor installation
- DC & AC Type II SPD: prevent lightning damage
- AFCI Function (Optional): when an arc-fault is detected the inverter immediately stops operation

	Ex9N-G-50kW	Ex9N-G50kW	Ex9N-G-60kW	Ex9N-G-60kW	Ex9N-G-66kW	Ex9N-G-70kW
<b>Input (DC)</b>						
Max. Input Power	80kW		96kW		105.6kW	112kW
Max. Input Voltage				1100V		
Start Voltage				250V		
Rated Input Voltage	600V				700V	
Full-load MPP Voltage Range	520V ~ 850V				600V ~ 850V	
MPPT Voltage Range	200V ~ 1000V					
Number of MPP Trackers	4					
Number of string per MPPT	3 / 2 / 3 / 2			3 / 3 / 3 / 3		
Max. Current per MPPT	39A / 26A / 39A / 26A			39A		
Max. Short Circuit Current per MPPT	48A / 32A / 48A / 32A			48A		
<b>Output (AC)</b>						
Max. Output Current	79.7A	66.2A	95.6A	79.4A	87.4A	92.6A
Rated Output Power	50kW		60kW		66kW	70kW
Max. Output Power	55kVA		66kVA		72.6kVA	77kVA
Rated Grid Frequency	50Hz / 60Hz					
Rated Grid Voltage	230Vac / 400Vac	277Vac / 480Vac	230Vac / 400Vac	277Vac / 480Vac		
Power Factor	>0.99 (0.8 leading~0.8 lagging)					
THDi	<3% (Rated Power)					
<b>Efficiency</b>						
Max. Efficiency	98.70%			98.80%		
European Efficiency	98.40%			98.50%		
MPPT Efficiency	99.90%					
<b>Protection</b>						
DC reverse polarity protection	Yes					
Anti-islanding protection	Yes					
AC short circuit protection	Yes					
Residual current monitoring unit	Yes					
Insulation resistance monitoring	Yes					
Ground fault monitoring	Yes					
Grid monitoring	Yes					
PV string monitoring	Yes					
Surge protection	Type II					
AFCI protection	Optional					
<b>Communication</b>						
Display	LED / LED+LCD / WIFI+APP					
Communication	Standard: RS485/ USB Optional: WIFI / GPRS / Ethernet					
<b>Standard Compliance</b>						
Grid Connection Standards	IEC 61727, IEC 62116, IEC 60068, IEC 61683, VDE-AR-N 4110:2018, VDE-AR-N 4105:2018, VDE-AR-N 4120:2018, EN 50549, AS/NZS 4777.2:2020, CEI 0-21, VDE 0126-1-1/A1 VFR 2014, UTE C15-712-1:2013, DEWA DRRG, NRS 097-2-1, MEA/PEA, C10/11, G98/G99					
Safety / EMC	IEC 62109-1:2010, IEC 62109-2:2011, EN 61000-6-2:2005, EN 61000-6-3:2007/A1:2011					
<b>General Data</b>						
Dimensions (W x H x D)	650 x 450 x 260 mm					
Weight	50kg					
Operating Temperature Range	-30° C ~ +60° C					
Cooling Method	Smart Cooling					
Protection Degree	IP66					
Max. Operating Altitude	4000m					
Relative Humidity	0 ~ 100%					
Topology	Transformerless					
Night Power Consumption	<1W					

# Ex9N-G 100-136kW

Three Phase On-Grid Solar Inverter



**Efficient  
Higher revenue**

- 9-12 MPP Trackers, high single circuit tracking accuracy, fast dynamic response and higher power generation
- 150% DC Input Oversizing
- Maximum efficiency of 98.7%. Wide MPPT voltage range: 180V-1000V
- Compatible with high power modules



**Intelligent  
Simple O&M**

- Smart I-V Curve Diagnosis Function: locate PV string faults accurately and automatically detect faults
- Intelligent Fault Detection: ac-side voltage and current waveforms real-time recorded, fast fault location
- Support RS485/USB (WiFi/DRM/Bluetooth optional): remote monitoring and operation via PC or mobile phones



**Reliable  
Worry free**

- IP66 Protection degree: support outdoor installation
- DC & AC Type II SPD: prevent lightning damage
- AFCI Function (Optional): when an arc-fault is detected the inverter immediately stops operation

	Ex9N-G-100kW	Ex9N-G-100kW	Ex9N-G-110kW	Ex9N-G-110kW	Ex9N-G-136kW	Ex9N-G-136kW	Ex9N-G-136kW	Ex9N-G-136kW
<b>Input (DC)</b>								
Max. Input Power	150kW				160kW			
Max. Input Voltage					1100V			
Start Voltage					250V			
Rated Input Voltage	620V				730V		780V	
Full-load MPP Voltage Range	530V ~ 850V				560V ~ 850V			
MPPT Voltage Range	180V ~ 1000V							
Number of MPP Trackers / String per MPPT	9 / 2		10 / 2		12 / 2			
Max. Current per MPPT	26A	30A	26A	30A	26A	30A	26A	30A
Max. Short Circuit Current per MPPT	40A							
<b>Output (AC)</b>								
Max. Output Current	158.8A				174.6A		160.4A	
Rated Output Power	100kW		110kW				136kW	
Max. Output Power	110kVA		121kVA				150kVA	
Rated Grid Frequency	50Hz / 60Hz							
Rated Grid Voltage	230Vac / 400Vac, 3L / N / PE, 3L / PE				277Vac / 480Vac, 3L / N / PE, 3L / PE		311Vac / 540Vac, 3L / N / PE, 3L / PE	
Power Factor	>0.99 (0.8 leading~0.8 lagging)							
THDi	<3% (Rated Power)							
<b>Efficiency</b>								
Max. Efficiency	98.70%							
European Efficiency	98.50%							
MPPT Efficiency	99.90%							
<b>Protection</b>								
DC reverse polarity protection	Yes							
Anti-islanding protection	Yes							
AC short circuit protection	Yes							
Residual current monitoring unit	Yes							
Insulation resistance monitoring	Yes							
Ground fault monitoring	Yes							
Grid monitoring	Yes							
PV string monitoring	Yes							
Surge protection	Type II							
AFCl protection	Optional							
PID recovery function	Optional							
SVG function	Optional							
<b>Communication</b>								
Display	LED / LCD / Bluetooth+App							
Communication	Standard: RS485/ USB Optional: WIFI / DRM / Bluetooth							
<b>Standard Compliance</b>								
Grid Connection Standards	IEC 61727, IEC 62116, IEC 60068, IEC 61683, VDE-AR-N 4110:2018, VDE-AR-N 4105:2018, VDE-AR-N 4120:2018, EN 50549, AS/NZS 4777.2:2020, CEI 0-21, VDE 0126-1-1/A1 VFR 2014, UTE C15-712-1:2013, DEWA DRRG, NRS 097-2-1, MEA/PEA, C10/11, G98/G99							
Safety / EMC	IEC 62109-1:2010, IEC 62109-2:2011, EN 61000-6-2:2005, EN 61000-6-3:2007/A1:2011							
<b>General Data</b>								
Dimensions (W x H x D)	1050 x 660 x 330 mm							
Weight	95kg		98kg		101kg			
Operating Temperature Range	-30° C ~ +60° C							
Cooling Method	Smart Cooling							
Protection Degree	IP66							
Max. Operating Altitude	4000m							
Relative Humidity	0 ~ 100%							
Topology	Transformerless							
Night Power Consumption	<1W							

# SOLAR STORAGE BATTERY INVERTER

LXP-LB 8K TRUE BACKUP POWER



- ALL-IN-ONE SOLUTION (PV, GENERATOR, ON/OFF GRID)
- MAX. 12 KW PV POWER DELIVERED TO BATTERY & AC OUTPUTS
- 8 KW (33.3A @240V) BACKUP POWER
- BUILT-IN MODULE LEVEL RAPID SHUTDOWN TRANSMITTER
- SUPPORTS LARGE BACKUP PANEL (21KW) WITH GRID
- FAST INSTALL & COMMISSIONING

## KEY FEATURES:

- IP65 rated for indoor & outdoor installations
- 2 MPPTs output for max Input 13KW PV array
- AC/DC Coupling
- 90A built-in auto transfer switch
- built-in Generator Input
- 10 units in parallel
- Online monitoring/app
- Color LCD touch screen

## SUPPORTED APPLICATIONS:

- ✓ **BACKUP**
- ✓ **OFF-GRID**
- ✓ **ZERO EXPORT**
- ✓ **TIME-OF-USE**
- ✓ **PEAK SHAVING**
- ✓ **VIRTUAL POWER PLANT**

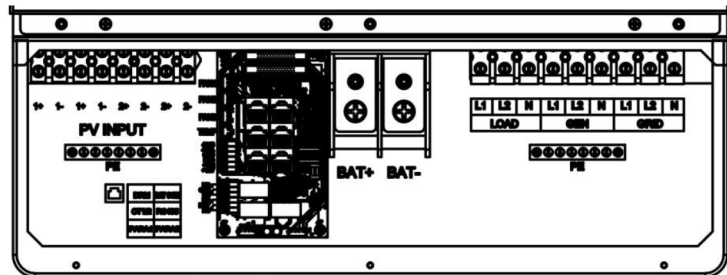
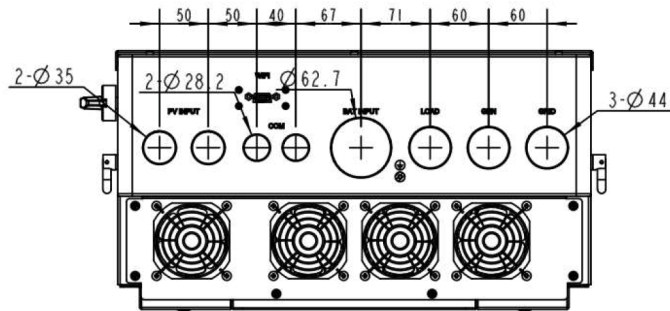
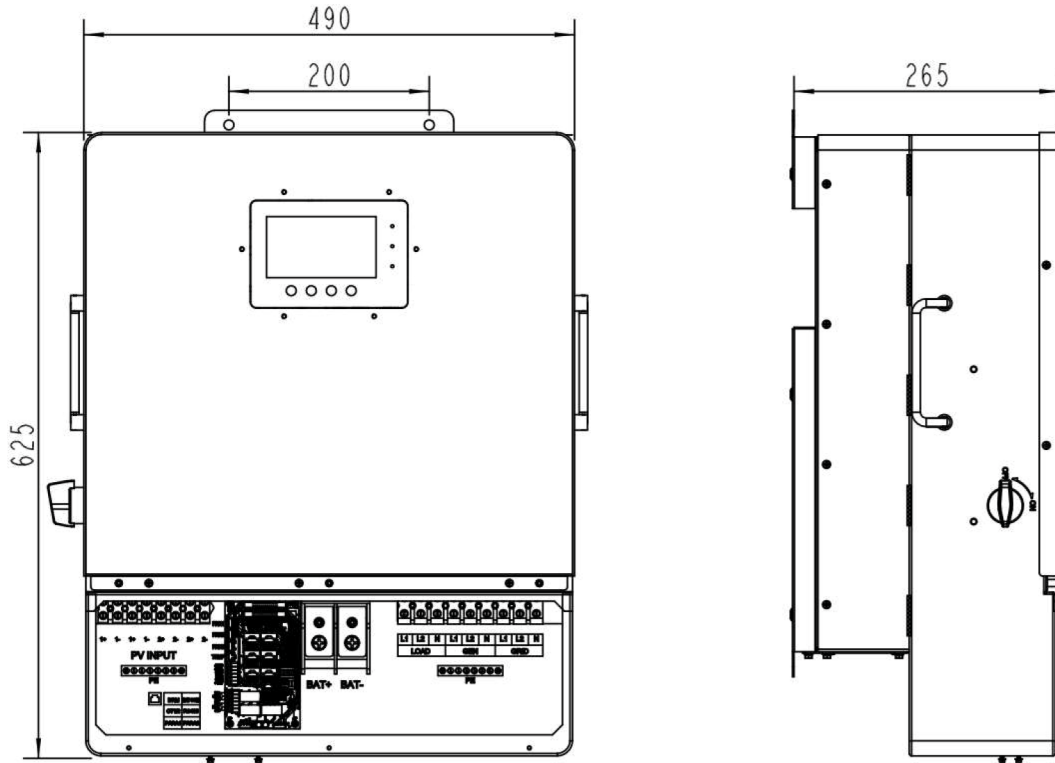



LXP-LB 8K

**Input DC (PV Side)**

Max. DC Input Power for Single MPPT	6000W / 6000 W
Max. PV Input Power	13000W
Max. PV Power Delivered to Battery & AC Outputs	12000W
DC Input Voltage Range	100V-600V
Nominal DC Input Voltage	360V
Full Power MPPT Voltage Range	170V-500V
Max. DC Input Current	25A / 25A
MPPT Number/(Strings per MPPT)	2 / 2

**Output/Inout AC (Grid)**

Continuous AC Power to Grid	8000W (240V)
Continuous AC Power to Load with Grid or Generator	21000W (240V)
Nominal Output Voltage	120V/240V
Max. Continuous AC Current	33.3A @ 240V
Nominal AC Frequency	50Hz/60Hz

**Output AC (Off-Grid)**

Max. Output Power	8000W
Nominal Output Voltage	120V/240V
Nominal Output Frequency	50Hz/60Hz
Nominal Output Current	33.3A @ 240V
Peak Power	16kW / 500ms
Switching Time	<10ms

**Battery Parameters**

Compatible Battery Type	Lithium or lead acid
Nominal Battery Voltage	48V
Battery Voltage Range	40V-60V
Maximum Charging/Discharging Current	167A
Maximum Charging/Discharging Power	8000W

**Efficiency**

MPPT Efficiency	99.9%
Max. Efficiency	97.5%
CEC Efficiency	96.5%

**Protection**

Anti-islanding Protection	YES
DC Switch	YES
Ingress Protect Degree	IP65
SPD Protection	YES
AFCI	OPT
RSD	OPT

**General Data**

Dimensions	580 x 490 x 265mm (22.8 x 19.3 x 10.4 in)
Weight	44kg (97lbs)
Display	Color LCD
Ambient Temperature Range	-25 - 60 C (-13 - 140 °F)
Cooling	FAN
Communication	RS485/Wi-Fi/CAN

**Standard & Certification**

Certifications	UL1741, UL1741 SA, IEE1547A, rule 21, ISO-NE, FCC15 class B, HECO, CEC, Luma (pending)
Warranty	5 or 10 Years



# WHOLE HOME SOLAR STORAGE BATTERY INVERTER

## LXP-LB 12K TRUE BACKUP POWER



- ALL-IN-ONE SOLUTION (PV, GENERATOR, ON/OFF GRID)
- WHOLE HOME BACKUP WITH 200A AC PASSTHROUGH
- MAX. 18KW PV POWER DELIVERED TO BATTERY & AC OUTPUTS
- 12 KW (50A @240V) BACKUP POWER
- BUILT-IN MODULE LEVEL RAPID SHUT-DOWN TRANSMITTER
- FAST INSTALL AND COMMISSIONING

### KEY FEATURES:

- 200A AC passthrough current for whole home backup
- 3 MPPT output for max. 21 kW PV array
- AC/DC coupling
- IP65 rated for Indoor & Outdoor Installation
- Built-in Generator Input
- 10 units in parallel
- Online monitoring/app
- Color LCD touch screen

### SUPPORTED APPLICATIONS:

- ✓ **BACKUP**
- ✓ **OFF-GRID**
- ✓ **ZERO EXPORT**
- ✓ **TIME-OF-USE**
- ✓ **PEAK SHAVING**
- ✓ **VIRTUAL POWER PLANT**

### Whole Home Backup One Line Diagram

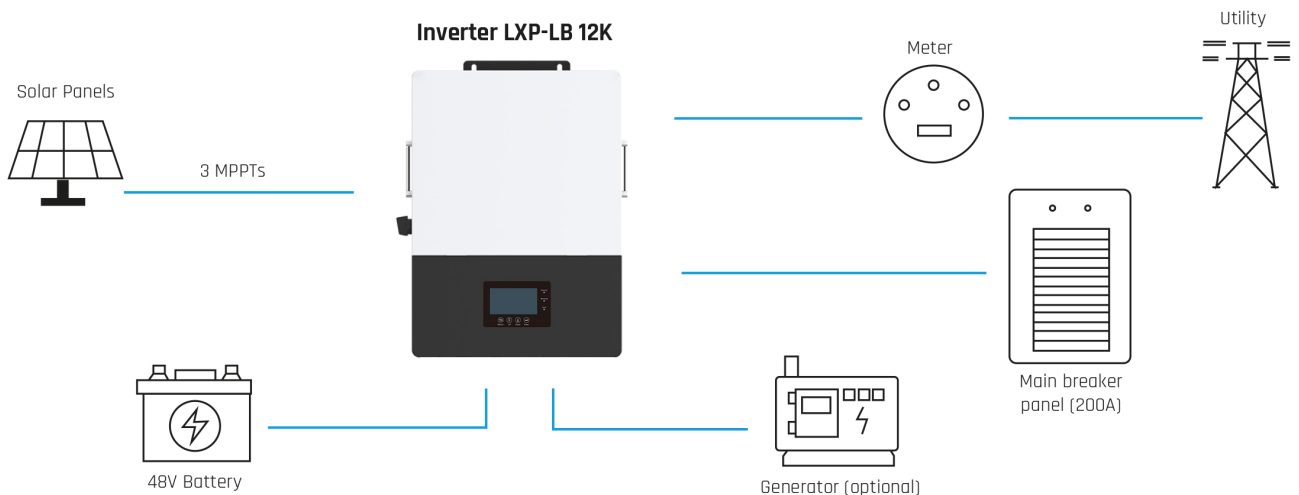

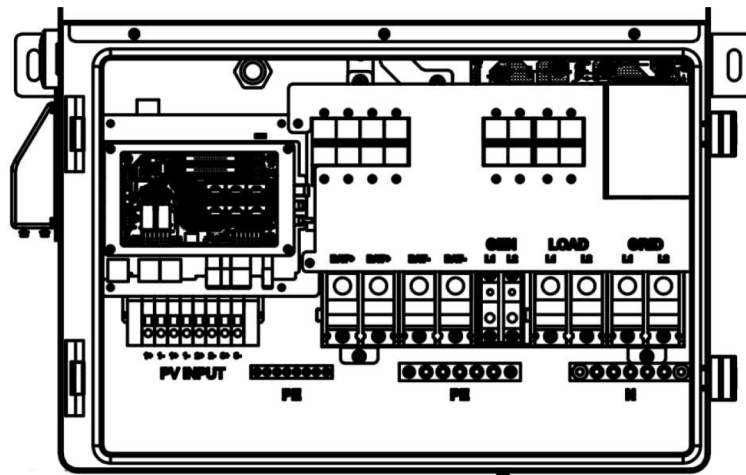
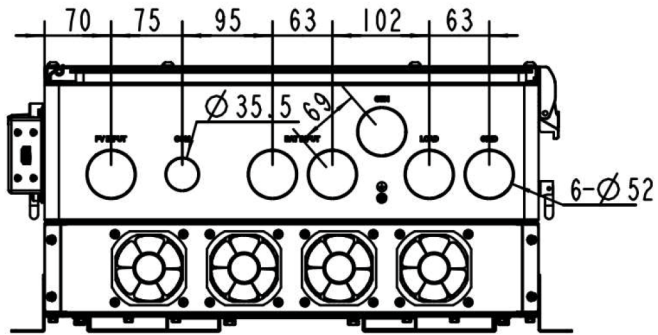
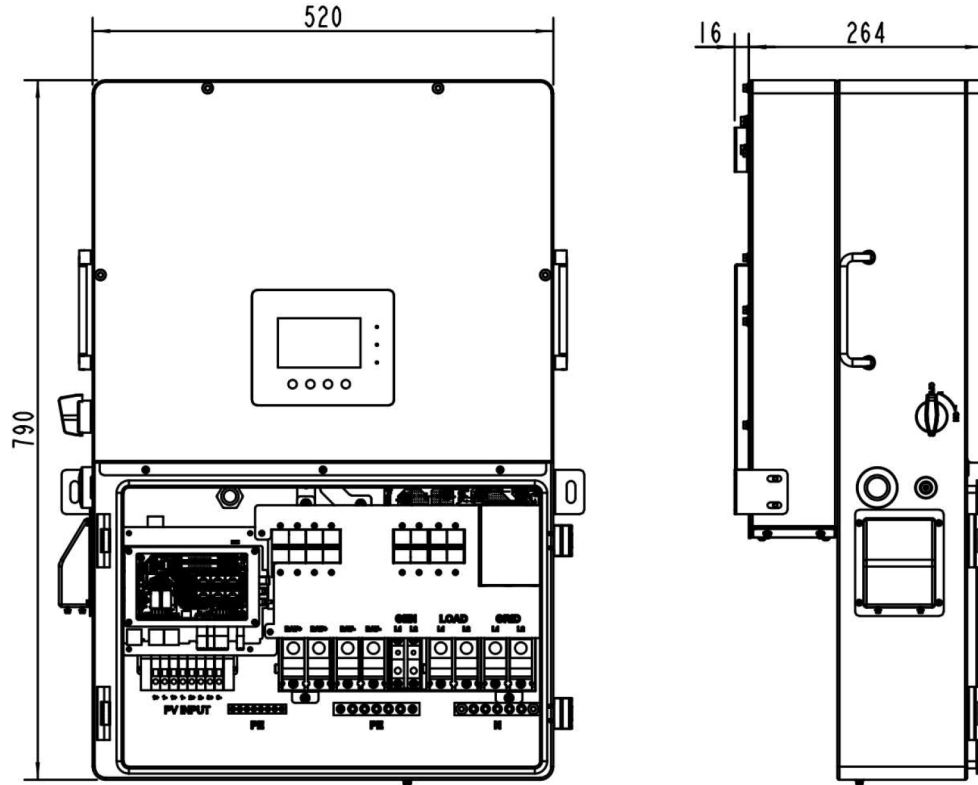



LXP-LB 12K

**Input DC (PV Side)**

Max. DC Input Power for Single MPPT	12000W/7000W/7000W 12kW x 1, 7kW x 2
Max. PV Input Power	21000W
Max. PV Power Delivered to Battery & AC Outputs	18000W
DC Input Voltage Range	100V-600V
Nominal DC Input Voltage	360V
Full Power MPPT Voltage Range	230V-500V
Max. DC Input Current	25A/15A/15A
MPPT Number/(Strings per MPPT)	3(2/1/1)

**Output/Inout AC (Grid)**

Conitnuous AC Power to Grid	12000W (240V)
Continuous AC Power to Load with Grid or Generator	48000W (240V)
Nominal Output Voltage	120V/240V
Max. Continuous AC Current	50A @ 240V
Nominal AC Frequency	50Hz/60Hz

**Output AC (Off-Grid)**

Max. Output Power	12000W (240V)
Nominal Output Voltage	120V/240V
Nominal Output Frequency	50Hz/60hZ
Nominal Output Current	50A @ 240V
Peak Power	14kW 10 minutes / 16kW 5 minutes / 20kW 500ms
Switching Time	<10ms

**Battery Parameters**

Compatible Battery Type	Lithium or lead acid
Nominal Battery Voltage	48V
Battery Voltage Range	48V-58V
Maximum Charging/Discharging Current	250A
Maximum Charging/Discharging Power	12000W

**Efficiency**

MPPT Efficiency	99.9%
Max. Efficiency	97.5%
CEC Efficiency	96.5%

**Protection**

Anti-islanding Protection	YES
DC Switch	YES
Ingress Protect Degree	IP65
SPD Protection	YES
AFCI	OPT
RSD	OPT

**General Data**

Dimensions	670 x 490 x 265 mm (26.4 x 19.3 x 10.4 in)
Weight	42kg (92.6lbs)
Display	Color LCD
Ambient Temperature Range	-20 - 60 C (-4 - 140 °F)
Cooling	FAN
Communication	RS485/Wi-Fi/CAN

**Standard & Certification**

Certifications	UL1741, UL1741 SA, IEEE1547A, rule 21, ISO-NE, FCC15 class B, HECO, CEC, Luma (pending)
Warranty	5 Years (Optional 10 Years)

# FORTRESS POWER

*eVault Max 18.5* Lithium Battery Storage



## KEEP YOUR HOME & BUSINESS SAFE AND CONNECTED WITH FORTRESS POWER



### LATEST TECHNOLOGY

We Use Long Lasting and Safe Tier 1 Lithium Iron Phosphate technology



### LARGEST CAPACITY

Full Home Back Up with the Largest Battery that is Scalable Up to 370kWh



### MAXIMIZE INVESTMENT

Reduce Electric Bill and Maximize Your Solar Investment with Battery Storage

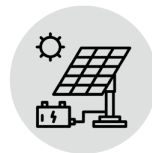

### GRID INDEPENDENCE

Achieve Grid Independence during Power Outages



### 10 YEAR WARRANTY

With Unlimited Partial Cycles

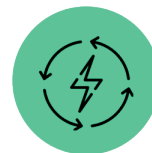

### 98% ROUND TRIP EFFICIENCY

Maximize Your Solar Energy Output

## WORLD'S LARGEST BATTERY FOR HOMES!

Our technology is capable of connecting 20 units in parallel to achieve 370kWh. These batteries connected in parallel can communicate with each other for voltage monitoring and balancing.

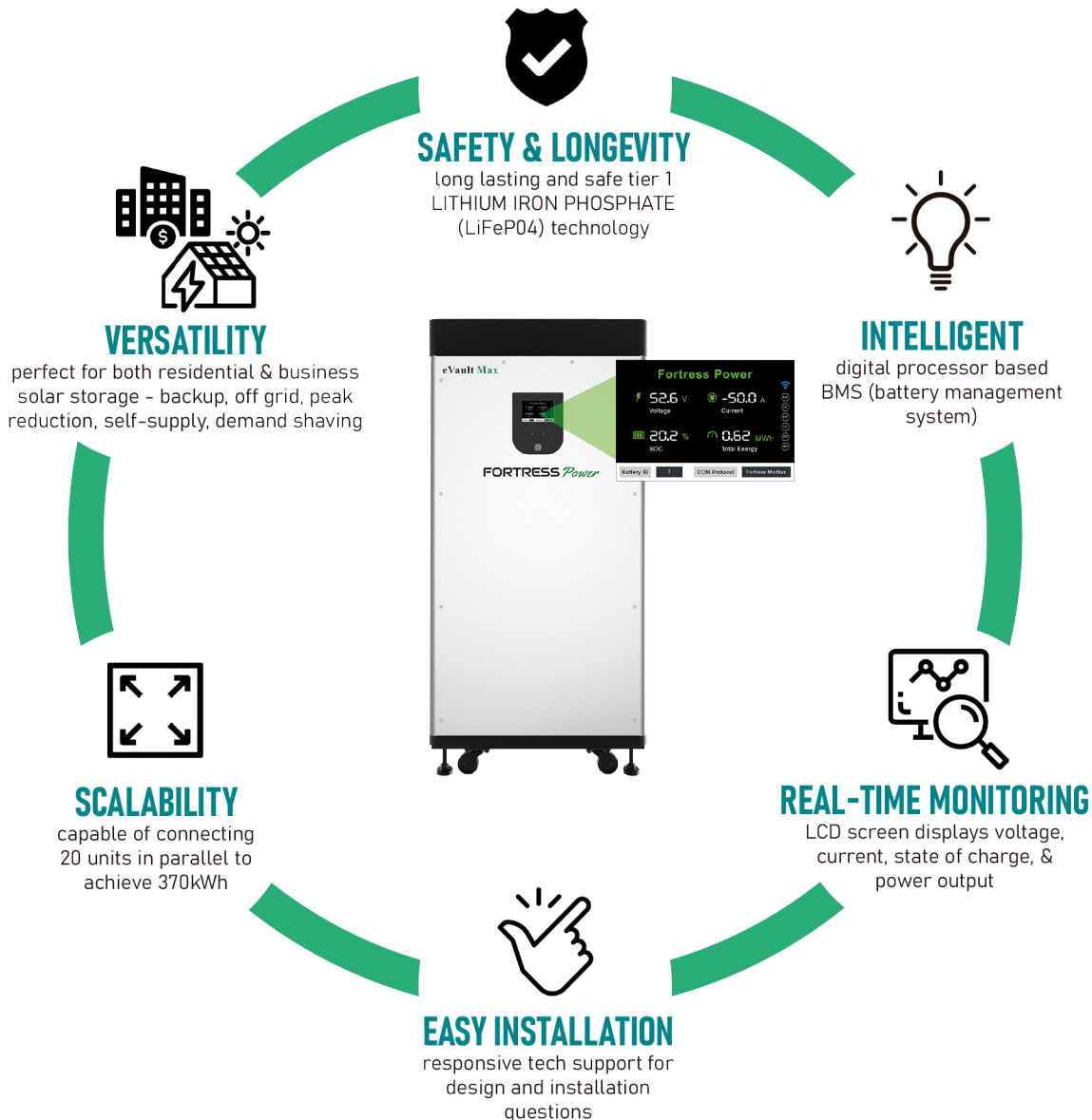

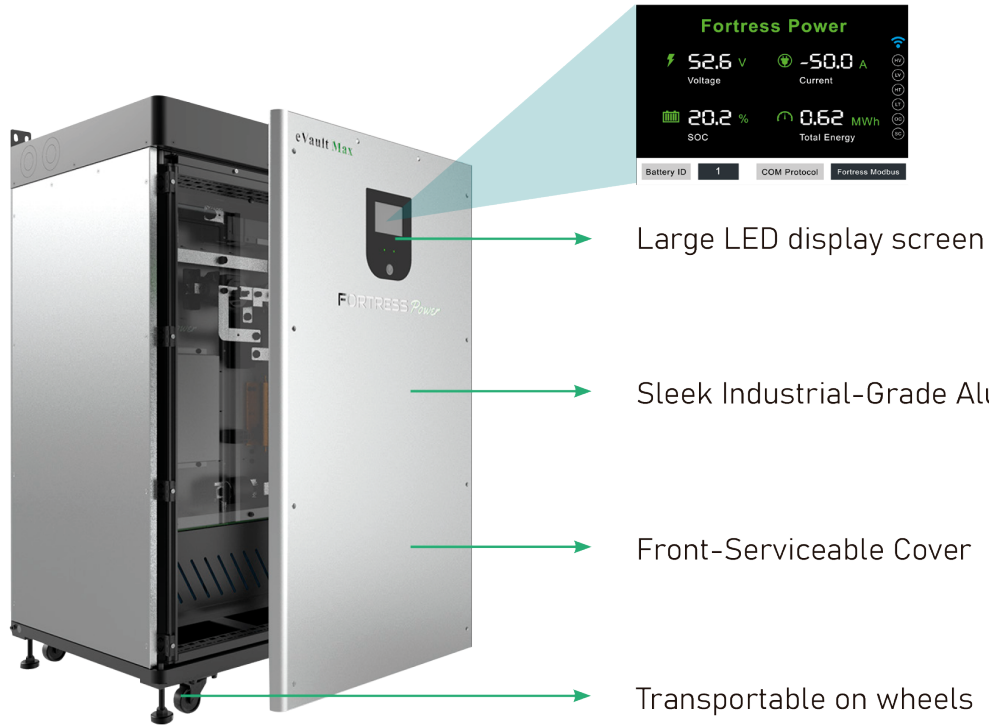

Large LED display screen

Sleek Industrial-Grade Aluminum

Front-Serviceable Cover

Transportable on wheels



Did you know that your solar system **STOPS WORKING** when the grid goes down?

With **Fortress Power**, you can use your solar power all day and night – even during grid outages!

- Provide power during grid outages
- Lower your electrical bill by avoiding having to buy electricity at peak times
- Enjoy a generous tax credit when incorporating with solar (US Only)
- Increase your independence from the utility grid

## FORTRESS POWER MISSION

Our mission is to provide compact, user-friendly and affordable lithium energy storage solutions using the latest technology for all homes and businesses. Fortress Power's smart and innovative energy storage units can be easily integrated with new and existing PV systems. They work by storing clean energy for when you need it most – it's that simple.

Our responsive technical support team is available for any questions or concerns at [techsupport@fortresspower.com](mailto:techsupport@fortresspower.com)



## HOW FORTRESS POWER COMPARES TO ALTERNATIVE POWER BACK-UP SOLUTIONS

	Fortress Power Solution	Other Lithium Ion Solution	Lead Acid	Generator
Applications	Backup power, time of use, self-use, & off-grid	Backup power, time of use, self-use, & off-grid	Backup power	Backup power
Depth of Discharge	100%	100%	50%	N/A
Potential Harm	Safest Technology	Potential fires and thermal runaway	Risk of harmful gases	Environmental pollution
Life Cycles	8,000 +	Up to 3,000	500 - 1,000	N/A
Warranty	10 years	10 years	2 years	2 years
Fuel Cost	\$0	\$0	\$0	\$50 - 100/day
Maintenance	No	No	Yes	Yes

### TECHNICAL SPECIFICATIONS EVULT MAX 18.5 KWH

Total Energy [kWh]	18.5
Capacity [Ah]	360
Nominal Voltage [V]	51.2 (48)
Voltage Range [V]	46 - 56
Recommended Charge Current [A]	150 (7.6 kW)
Max. Charge Current (Continuous) [A]	180 (9.2 kW)
Max. Discharge Current (Continuous) [A]	230 (12 kW 30 min)
Max. Pulse Current (for 10 sec) [A]	250 (12.8 kW 5 sec)
Charge Temperature [F]	32°F ~ 120°F (0°C ~ 49°C)
Discharge Temperature [F]	-4°F ~ 140°F (-20°C ~ 60°C)
Recommended Storage Temperature [F]	6 months: 14°F ~ 77°F (-10°C ~ 25°C) 3 months: -4°F ~ 113°F (-20°C ~ 45°C)
Dimension [WxDxH, inch]	20.3" x 20.3" x 42.2" (515 x 515 x 1073 mm)
Weight [lbs]	520
Enclosure Protection Rating	IP55
Mounting Options	Floor standing
Certificates	UL 1642, UL 1973, UL 9540, CEC, SGIP
Warranty	10 years
Life Cycle	8,000 Cycles (@ 80% DoD)
Depth of Discharge (DOD)	up to 100%
Scalability	Maximum 20 in Parallel (370 kWh)
Communication	CAN/RS485
High Current Circuit Breaker	250A
Efficiency	> 98%

### ABOUT FORTRESS POWER

Fortress Power proudly services homes, businesses, utilities, telecom and transportation companies worldwide. Our Pennsylvania-based team's passion for clean energy storage has earned us a place among the world's top energy storage battery manufacturers.

Our logistics centers located across the country offer easy distribution to all of our major markets. Fortress Power's high-performance solar lithium battery storage products are designed, engineered and inventoried along with live technical support in the United States.

Fortress Power has partnered with industry leading lending institutions to help make your solar investment as easy as possible. Please visit our website for purchasing and financing options.

Compatible with Most Inverters on the Market

Schneider Sol-Ark Midnite Solar OutBack Power SMA Morningstar Phocos Victron Energy Growatt



Fortress Power is a manufacturer of high-performance solar lithium battery storage products that are designed, engineered and inventoried along with live technical support in the United States

# FORTRESS POWER *eFlex*

*eFlex 5.4* Lithium Battery Storage



## Energy Savings & Security with Fortress Power



SCAN FOR  
INSTALLATION  
MANUAL



Maximize Your Solar Investment with Battery Storage



Achieve Grid Independence during Power Outages



Reduce Your Electric Bill



Versatile Applications including Home, Business, Mobile, Telecom and Railway

www.fortresspower.com



UL 9540  
UL 9540A  
UL 1973



**FORTRESS  
POWER**  
Secure your energy



# eFlex 5.4 kWh Solar Storage Battery

## Taking Innovation to the Next Level

Safest Lithium Technology (LiFeP04) on the market

MODbus and CANbus Communication for Internet-of-Things Compatibility

98% Round-trip Efficiency

IP65 Dust and Water Proof Design for Outdoor Installs

10 Year Warranty with Unlimited Partial Cycles

Data communication with popular hybrid inverters

Market Leading BMS Battery to Maximize Reliability and Longevity

## Versatile Applications

### Designed For Multiple Project Scenarios

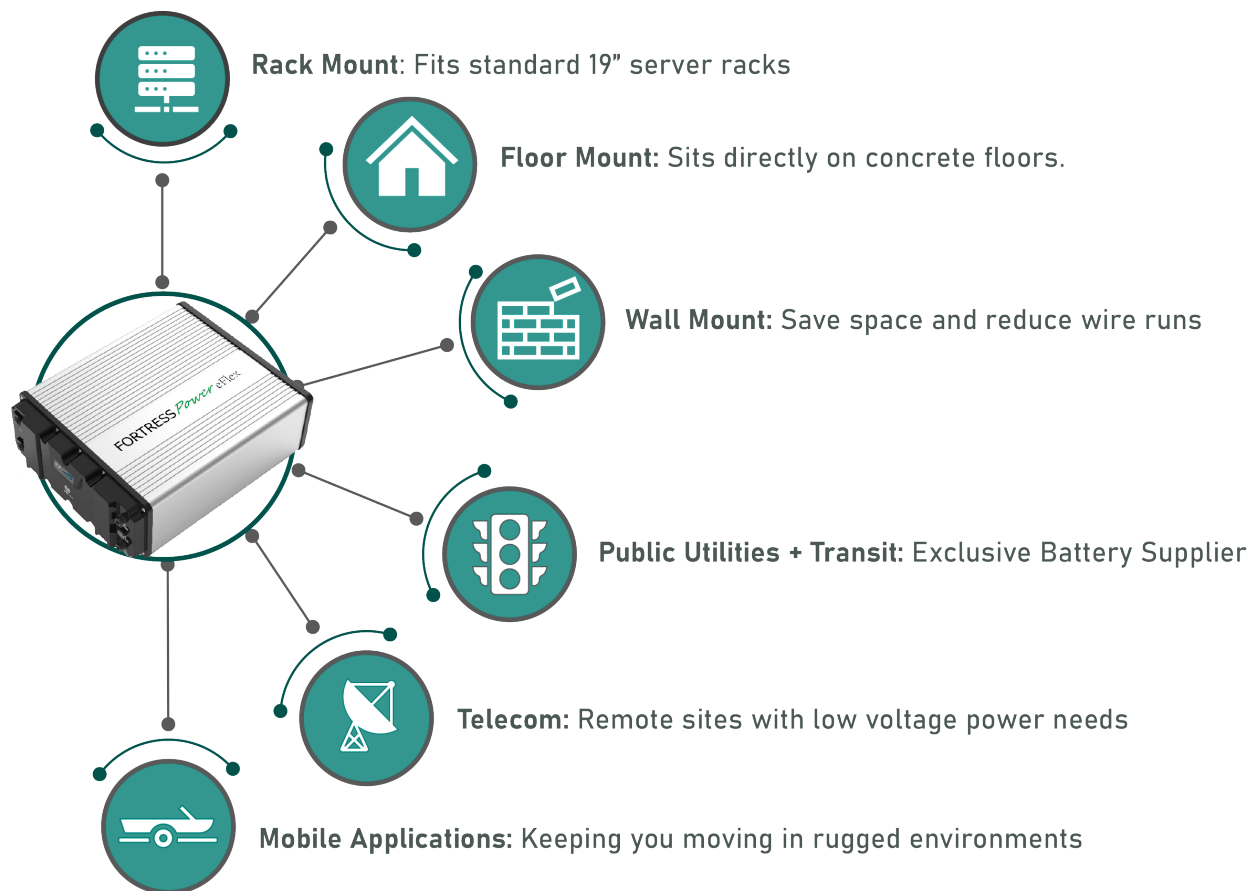

*"You Think It - We'll Power It"*



## eFlex 5.4 kWh Lithium Storage Battery

	<i>eFlex 5.4</i>
Cell Type	Tier 1 Automotive Prismatic LiFePO4
Total Energy (kWh)	5.4
Max. Charge Current (Continuous) [A]	100
Max. Discharge Current (Continuous) [A]	100
Max. Pulse Current (for 5sec) [A]	130
Capacity [Ah]	105
Voltage Range [V]	44-58.4
Charging Temperature [F]	32 to 114 (0 C - 45 C)
Discharging Temperature [F]	-4 to 131 (-20 C - 55 C)
Storage Temperature [F]	20 to 95 (-6 C to 35C)
Dimension [LxWxH, Inch]	18 x 23 x 7.3 ( 446 x 546 x 193 mm)
Weight [lbs]	108 (49 kg)
Warranty	10 Years
Life Cycles	8,000 @ 80% DoD
Round Trip Efficiency	>98%
Depth of Discharge	Up to 100%
Scalability	Max 15 Units (81 kWh)
Enclosure Protection	IP65 for water and dust protection
Certifications	UL9540, UL9540A, UL1973, UL1642, CEC, SGIP, UN 38.3

Compatible with Most Inverters on the Market

Schneider Sol-Ark Midnite Solar OutBack Power SMA Morningstar Phocos Victron Energy Growatt

### ABOUT FORTRESS POWER

Fortress Power proudly services homes, businesses, utilities, telecom and transportation companies worldwide. Our Pennsylvania-based team's passion for clean energy storage has earned us a place among the world's top energy storage battery manufacturers.

Our logistics centers in California, Florida and Pennsylvania offer easy distribution to all of our major markets. Fortress Power's high-performance solar lithium battery storage products are designed, engineered and inventoried along with live technical support in the United States.

Fortress Power has partnered with industry leading lending institutions to help make your solar investment as easy as possible. Please visit our website for purchasing and financing options.



**5K-120V /  
8K-230V-1P**  
**Ficha Técnica**



Datos de Entrada Solar	
Energía Fotovoltaica (FV) Permitida	10400W
Voltaje Fotovoltaico de Entrada	370V (100~500V)
Corriente Fotovoltaica de Entrada	20A + 20A
Corriente Cortocircuito Máxima (Isc)	26A + 26A
Voltaje de Arranque / Voltaje Min	150V
Numero de MPPT / Rango (V)	2 / 125-425V
Cadenas Solares Máximas por MPPT	2 + 2
Eficiencia de los MPPT	99.90%

Datos de Salida AC	5K	8K
Tipo de Red Eléctrica (Monofásico)	120V 1P	230V/240V 1P
Salida Nominal AC	5000W	8000W
Potencia Máxima (Off-Grid)	10000W, 10S	PENDIENTE
Corriente Nominal de Salida AC	41.7 A	34.8 A
Apilabilidad en Paralelo	Si — Hasta 8	
Frecuencia	60/50Hz	
Paso Continuo Máximo AC (A)	45A	45A
Eficiencia Máxima	97.6%	
Potencia de Ralentí- Sin Carga	PENDIENTE	
Modos de Ventas de Energía	Limitado al Hogar / Conectado a la Red	
Diseño (DC → AC)	Sin Transformador DC	
Tiempo de Respuesta (Grid-Tied to Off-Grid)	5ms	
Factor de potencia	+/- 0.9 - 1.0	

### Datos de Entrada de la Batería (Opcional)

Tipo	Acido-Plomo or Li-Ion
Entrada DC Nominal	48V
Capacidad	50 — 9900Ah
Rango de Voltaje	40V-60V
Salida de Carga Continua de Batería	120A
Curva de Carga	3-Etapas con Equalización
Eficiencia de Carga de Grid a Bat	96.0%
Sensor de Temperatura Externo	Incluido
Shunt de Corriente x % SOC Preciso	Integrado
GEN Start Externo basado en Voltaje	Integrado
Comunicación con Baterías LiFePo4	CanBus & RS485

### General

Dimensiones (H x W x D)	580 x 330 x 232 mm
Peso	20.5 kg
Recinto (Caja)	IP65 / NEMA 3R
Temperatura Ambiente	-25~60°C, >45°C Antes de reducción
Ruido/Sonido	<30 dB
Estilo de Instalación	Mural
Comunicación Wi-Fi y LAN	Incluido
Garantía Estándar	5 Años (10 Años USA)

### Protecciones y Certificaciones

Protección contra rayos en la entrada FV	Si
Venta Hacia la Red — UL1741-2010/2018, IEEE1547a-2003/2014	Si
Protección Contra el Aislamiento	Integrado
Protección Contra Polaridad Inversa de FV	Integrado
Detección de la Resistencia de Aislamiento	Integrado
Unidad de Control de la Corriente Residual	Integrado
Protección Contra Sobrecorriente de Salida	Integrado
Protección de la Salida en Cortocircuito	Integrado
Protección Contra Sobrecargas	DC Tipo II / AC Tipo II



# Sol-Ark

## 12K-P

### Spec Sheet



Solar Potencia a Entrada: 12000W	
Energía Fotovoltaica (PV) Permitida	6500W + 6500W = 13000W
PV Max Enviado A Batería y Salidas AC	12000W
Voltaje DC Max	500V @ 18A, 450V @ 20A
Rango de Voltaje de MPPTs	150-425V
Voltage de Arranque	125V
Numero de MPPT	2
Max Solar Strings x Cada MPPT	2
Corriente DC Max x MPPT (Autolimitante)	20A
Entrada de Acoplamiento AC Max (Micro/inversores string)	9600W

AC Pot. A Salida 9 kW On-Grid Y Off-Grid	
Conexiones	120/240/208V Split Phase
Potencia AC Continua al Grid (On-Grid)	9000W 37.5A-L (240V)
Potencia AC Continua hacia Cargas (Off-Grid)	9000W 37.5A-L (240V)
Sobrecarga AC x 10 Segundos	16000VA L-L (240V)
Sobrecarga AC x 100 mSegundos	25,000VA L-L(240V)
Apliamiento en Paralelo	Si
Frecuencia	60/50Hz
Potencia AC Continua con Grid / Generador	15120W 63A L-L (240V) 7560W 63A L-N (120V)
Eficiencia CEC	96.5% (Peak 97.5%)
Cons. de Energía en Reposo (sin Carga)	60W
Modos de Ventas de Energía	Limitado al Hogar / Completamente Grid-Tied
Diseño (DC hacia AC)	Sin Transformador DC
Tiempo de Respuesta (On/Off-Grid)	4ms
Factor de Potencia	+/- 0.9 - 1.0

### Batería (opcional) Potencia a Salida 9000W

Tipo	Acido-Plomo or Li-Ion
Entrada DC Nominal	48V
Capacidad	50 — 9900Ah
Rango de Voltaje	43.0 — 63.0V
Salida de Carga Continua de Batería	185A
Curva de Carga	3-Etapas con Equalización
Eficiencia de Carga de Grid a Bat	96.0%
Sensor de Temperatura Externo	Incluido
Shunt de Corriente x % SOC Preciso	Integrado
GEN Start Externo basado en Voltaje o Estado de Carga	Integrado
Comunicación con Baterías LiFePo4	CanBus & RS485

### General

Dimensiones (H x W x D)	31.8" x 18.3" x 10.9"
Peso	78 lbs
Recinto (Caja)	NEMA 3R
Temperatura Ambiente	-40-55°C, >45°C Derrateo
Estilo de Instalación	Mural
Comunicación Wi-Fi y LAN	Incluido
Garantía estándar (verificado x HALT Testing)	10 Años

### Protecciones & Certificaciones

Seguridad Electronica Certificada x SGS Labs a Specs de NEC & UL - NEC 690.4B / NEC 705.4/6	Si
Grid Sell Back — UL1741-2010/2018, IEE-E1547a-2003/2014, FCC 15 Class B, UL1741SA, CA Rule 21, HECO Rule 14H	Si
Interruptor de desconexión PV — NEC 240.15	Integrado
Detección de Fallos a Tierra — NEC 690.5	Integrado
Control de Apago Rápido de PV — NEC 690.12	Integrado
Detección de PV Arc Fault — NEC 690.11	Integrado
Protección de entrada PV contra rayos	Integrado
Protección Contra Polaridad Inversa de PV	Integrado
Disyuntor de Salida AC - 200A	Integrado
Disyuntor/ Desconecto de Batería - 300A	Integrado
Protección Surge	DC Tipo II / AC Tipo II



LIMITLESS

15K-LV

Ficha Técnica



### Solar Potencia a Entrada: 17000W

Energía Fotovoltaica (FV) Permitida	17000W
FV Max Enviado A Batería y salidas AC	16000W
Voltaje DC Max	500V @ 26A
Rango de Voltaje de MPPTs	125-425V
Voltage de Arranque	125V
Numero de MPPTs	3
Max Solar Strings x cada MPPT	2
Corriente DC Max x MPPT (Autolimitante)	26A
Entrada de Acoplamiento AC Max (Micro/inversores string)	24000W

### AC Pot. A Salida 15 kW On-Grid Y Off-Grid

Conexiones	120/240/208V
Potencia AC Continua al Grid (On-Grid)	15000W 62.5A-L (240V)
Pot. AC Cont. hacia Cargas (Off-Grid)	12000W 50A-L (240V)
Sobrecarga AC x 10 Segundos	24,000VA L-L (240V)
Sobrecarga AC x 100 mSegundos	PENDIENTE
Apliamiento en Paralelo	Si— Hasta 12
Frecuencia	60/50Hz
Potencia AC Continua con Grid / Generador	48000W 200A L-L (240V)
Eficiencia CEC	96.5% (Peak 97.5%)
Cons. de Energía en Reposo (sin Carga)	PENDIENTE
Modos de Ventas de Energía	Limitado al Hogar / Conectado
Diseño (DC hacia AC)	Sin Transformador DC
Tiempo de Respuesta (On/Off-Grid)	5ms
Factor de Potencia	+/- 0.9 - 1.0

### Batería (Op.) Potencia de Salida 12000W

Tipo	Acido-Plomo or Li-Ion
Entrada DC Nominal	48V
Capacidad	50 — 9900Ah
Rango de Voltaje	43.0 — 63.0V
Salida de Carga Continua de Batería	275A
Curva de Carga	3-Etapas con Equalización
Eficiencia de Carga de Grid a Bat	96.0%
Sensor de Temperatura Externo	Incluido
Shunt de Corriente x % SOC Preciso	Integrado
GEN Start Externo basado en Voltaje o Estado de Carga	Integrado
Comunicación con Baterías LiFePo4	CanBus & RS485

### General

Dimensiones (H x W x D)	807.7 x 464.8 x 276.9 mm
Peso	38.6 kg
Recinto (Caja)	IP65 / NEMA 3R
Temperatura Ambiente	-40~60°C, >45°C Antes de reducción
Estilo de Instalación	Mural
Comunicación Wi-Fi y LAN	Incluido
Garantía estándar (verificado x HALT Testing)	10 Años

### Protecciones y Certificaciones

Seguridad Electronica Certificada x SGS Labs a Specs de NEC & UL - NEC 690.4B / NEC 705.4/6	Si
Venta Hacia la Red — UL1741-2010/2018, IEEE1547a-2003/2014, FCC 15 Class B, UL1741SA, CA Rule 21, HECO Rule 14H	Si
Interruptor de desconexión FV — NEC 240.15	Integrado
Detección de Fallos a Tierra — NEC 690.5	Integrado
Control de Apago Rápido de FV — NEC 690.12	Integrado
Detección de FV Arc Fault — NEC 690.11	Integrado
Protección de entrada FV contra rayos	Integrado
Protección Contra Polaridad Inversa de FV	Integrado
Disyuntor de Salida AC - 200A	Integrado
Disyuntor/ Desconecto de Batería - 200A x 2	Integrado
Protección Contra Sobrecargas	DC Tipo II / AC Tipo II

Certificados UL Próximamente\*



**YLM-J**  
**108 Cell**  
**(M10)**

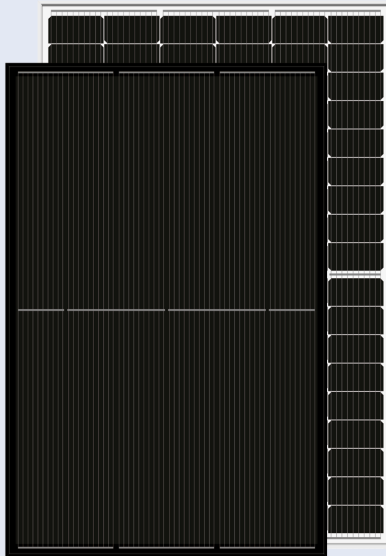

**22.5%**  
 CELL EFFICIENCY

**12 YEAR**  
 PRODUCT WARRANTY

**0 - 5W**  
 POWER TOLERANCE

**25 Years Linear Warranty**

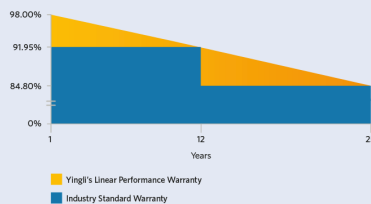

**IMPROVED POWER**  
**NEVER SETTLE FOR LESS**

Choosing the best P-type monocrystalline cells, YLM series modules are making the best out of your system. Trust in the expertise of Yingli and well proven technology.



**Higher Durability**

The multi-busbar design can decrease the risk of the cell micro-cracks and fingers broken.



**High Power Density**

High conversion efficiency and more power output per square meter, by lower series resistance and improved light harvesting.



**Half-cell Design**

Less energy loss caused by shading due to new cell string layout and split J-box, and lower cell connection power loss due to half-cell design.



**Optimized dimension**

More flexibly in residential and commercial rooftop installation.

**Yingli Solar**

Yingli Energy (China) Company Limited, known as "Yingli Solar", is one of the world's leading solar panel manufacturers with the mission to provide affordable green energy for all. Yingli Solar makes solar power possible for communities everywhere by using our global manufacturing and logistics expertise to address unique local challenges.

# YLM-J 108 Cell (M10)

## ELECTRICAL PERFORMANCE

### Electrical parameters at Standard Test Conditions (STC)

Module type	YLxxxD-37e 1/2(xxx=Pmax) YLxxxD-37e 1500V 1/2(xxx=Pmax)					
Power output	$P_{max}$	W	400	405	410	415
Power output tolerances	$\Delta P_{max}$	W	0 / +5			
Module efficiency	$\eta_m$	%	20.5	20.7	21.0	21.3
Voltage at $P_{max}$	$V_{mpp}$	V	30.65	30.80	30.95	31.10
Current at $P_{max}$	$I_{mpp}$	A	13.06	13.15	13.25	13.35
Open-circuit voltage	$V_{oc}$	V	37.06	37.17	37.28	37.39
Short-circuit current	$I_{sc}$	A	13.78	13.86	13.94	14.02

STC: 1000W/m<sup>2</sup> irradiance, 25°C cell temperature, AM1.5g spectrum according to EN 60904-3.  
Average relative efficiency reduction of 3.3% at 200W/m<sup>2</sup> according to EN 60904-1.

### Electrical parameters at Nominal Operating Cell Temperature (NOCT)

Power output	$P_{max}$	W	297.6	301.3	305.0	308.8
Voltage at $P_{max}$	$V_{mpp}$	V	28.5	28.6	28.8	28.9
Current at $P_{max}$	$I_{mpp}$	A	10.45	10.52	10.60	10.68
Open-circuit voltage	$V_{oc}$	V	34.7	34.8	34.9	35.0
Short-circuit current	$I_{sc}$	A	11.13	11.20	11.26	11.33

NOCT: open-circuit module operation temperature at 800W/m<sup>2</sup> irradiance, 20°C ambient temperature, 1m/s wind speed.

## THERMAL CHARACTERISTICS

Nominal operating cell temperature	NOCT	°C	45±2
Temperature coefficient of $P_{max}$	$\gamma$	%/°C	-0.35
Temperature coefficient of $V_{oc}$	$\beta_{Voc}$	%/°C	-0.27
Temperature coefficient of $I_{sc}$	$\alpha_{Isc}$	%/°C	0.05

## OPERATING CONDITIONS

Max. system voltage	1000V <sub>DC</sub> /1500V <sub>DC</sub>
Max. series fuse rating *	25A
Operating temperature range	-40°C to 85°C
Max. static load, front (e.g., snow)	5400Pa
Max. static load, back (e.g., wind)	2400Pa
Max. hailstone impact (diameter / velocity)	25mm / 23m/s

\* DO NOT CONNECT FUSE IN COMBINER BOX WITH TWO OR MORE STRINGS IN PARALLEL CONNECTION.

## CONSTRUCTION MATERIALS

Front cover (material / thickness)	low-iron tempered glass / 3.2mm
Cell (quantity / material)	108/ monocrystalline silicon
Frame (material)	anodized aluminum alloy
Junction box (protection degree)	≥ IP67
Cable (length / cross-sectional area)	1100mm/ 4mm <sup>2</sup>

\* Due to continuous innovation, research and product improvement, the specifications in this product information sheet are subject to change without prior notice. The specifications may deviate slightly and are not guaranteed.

\* The data do not refer to a single module and they are not part of the offer, they only serve for comparison to different module types.

## QUALIFICATIONS & CERTIFICATES

IEC 61215, IEC 61730, CE, ISO 9001:2015, ISO 14001:2015, BS OHSAS 18001:2007



## GENERAL CHARACTERISTICS

Dimensions (L / W / H)	1722mm / 1134mm / 30mm
Weight	21.5kg

## PACKAGING SPECIFICATIONS

Number of modules per pallet	36
Number of pallets per 40' container	26
Packaging box dimensions (L / W / H)	1740mm / 1110mm / 1245mm
Box weight	810kg

Unit: mm

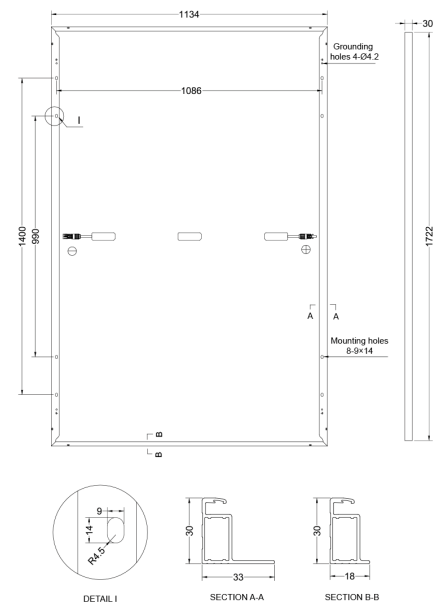

**Warning:** Read the Installation and User Manual in its entirety before handling, installing and operating Yingli Solar modules.



# YLM-J 144 CELL (M10)

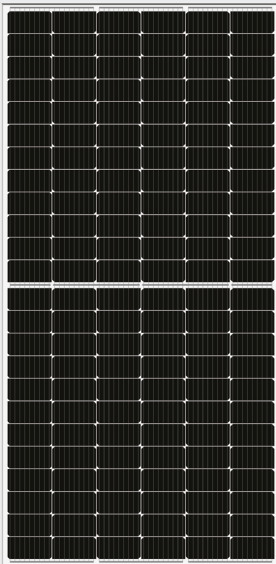

**22.5%**  
CELL EFFICIENCY

**12 YEAR**  
PRODUCT WARRANTY

**0 - 5W**  
POWER TOLERANCE

## 25 Years Linear Warranty

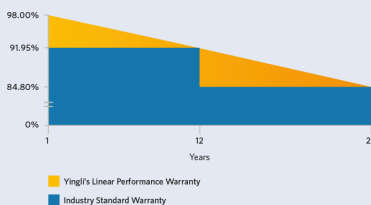

# IMPROVED POWER NEVER SETTLE FOR LESS

YLM series product, using multi-busbar design, reduced the cells silver paste consumption, improved cells efficiency, achieved the higher modules power output.



### Higher Durability

The multi-busbar design can decrease the risk of the cell micro-cracks and fingers broken.



### High Power Density

High conversion efficiency and more power output per square meter, by lower series resistance and improved light harvesting.



### Half-cell Design

Less energy loss caused by shading due to new cell string layout and split J-box, and lower cell connection power loss due to half-cell design.



### Large size cell

The large cell design effectively increases module peak power and effectively reduces BOS costs, thereby reducing system costs.

## Yingli Solar

Yingli Energy (China) Company Limited, known as "Yingli Solar", is one of the world's leading solar panel manufacturers with the mission to provide affordable green energy for all. Yingli Solar makes solar power possible for communities everywhere by using our global manufacturing and logistics expertise to address unique local challenges.



# YLM-J 144 CELL (M10)

## ELECTRICAL PERFORMANCE

### Electrical parameters at Standard Test Conditions (STC)

Module type	YLxxxD-49e 1/2 (xxx=Pmax)				YLxxxD-49e 1500V 1/2 (xxx=Pmax)			
Power output	$P_{max}$	W	530	535	540	545		
Power output tolerances	$\Delta P_{max}$	W	0/+5					
Module efficiency	$\eta_m$	%	20.51	20.70	20.89	21.09		
Voltage at $P_{max}$	$V_{mpp}$	V	41.40	41.55	41.70	41.85		
Current at $P_{max}$	$I_{mpp}$	A	12.81	12.88	12.95	13.03		
Open-circuit voltage	$V_{oc}$	V	49.22	49.37	49.52	49.67		
Short-circuit current	$I_{sc}$	A	13.69	13.76	13.83	13.90		

STC: 1000W/m<sup>2</sup> irradiance, 25°C module temperature, AM1.5g spectrum according to EN 60904-3.  
Average relative efficiency reduction of 3.3% at 200W/m<sup>2</sup> according to EN 60904-1.

### Electrical parameters at Nominal Operating Cell Temperature (NOCT)

Module type	YLxxxD-49e 1/2 (xxx=Pmax)				YLxxxD-49e 1500V 1/2 (xxx=Pmax)			
Power output	$P_{max}$	W	394.3	398.0	401.8	405.5		
Voltage at $P_{max}$	$V_{mpp}$	V	38.5	38.6	38.8	38.9		
Current at $P_{max}$	$I_{mpp}$	A	10.25	10.30	10.36	10.42		
Open-circuit voltage	$V_{oc}$	V	46.1	46.2	46.4	46.5		
Short-circuit current	$I_{sc}$	A	11.06	11.12	11.17	11.23		

NOCT: open-circuit module operation temperature at 800W/m<sup>2</sup> irradiance, 20°C ambient temperature, 1m/s wind speed.

## THERMAL CHARACTERISTICS

Parameter	NOCT	°C	Value
Nominal operating cell temperature	NOCT	°C	45±2
Temperature coefficient of $P_{max}$	$\gamma$	%/°C	-0.35
Temperature coefficient of $V_{oc}$	$\beta_{voc}$	%/°C	-0.27
Temperature coefficient of $I_{sc}$	$\alpha_{isc}$	%/°C	0.05

## OPERATING CONDITIONS

Max. system voltage	1000V <sub>DC</sub> or 1500V <sub>DC</sub>
Max. series fuse rating	25A
Operating temperature range	-40°C to 85°C
Max. static load, front (e.g., snow)	5400Pa
Max. static load, back (e.g., wind)	2400Pa
Max. hailstone impact (diameter / velocity)	25mm / 23m/s

\* DO NOT CONNECT FUSE IN COMBINER BOX WITH TWO OR MORE STRINGS IN PARALLEL CONNECTION

## CONSTRUCTION MATERIALS

Front cover (material / thickness)	low-iron tempered glass / 3.2mm
Cell (quantity / material)	144 / monocrystalline silicon
Frame (material)	anodized aluminum alloy
Junction box (protection degree)	≥ IP67
Cable (length / cross-sectional area)	300 mm / 4mm <sup>2</sup>

- Due to continuous innovation, research and product improvement, the specifications in this product information sheet are subject to change without prior notice. The specifications may deviate slightly and are not guaranteed.
- The data do not refer to a single module and they are not part of the offer, they only serve for comparison to different module types.

## QUALIFICATIONS & CERTIFICATES

IEC 61215, IEC 61730, CE, CQC, ISO 9001:2015, ISO 14001:2004, BS OHSAS 18001:2007



## GENERAL CHARACTERISTICS

Dimensions (L / W / H)	2279×1134×35 mm
Weight	28.6kg

## PACKAGING SPECIFICATIONS

Number of modules per pallet	31
Number of pallets per 40' container	20
Packaging box dimensions (L / W / H)	2295×1110×1245 mm
Box weight	942kg

Unit: mm

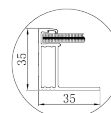
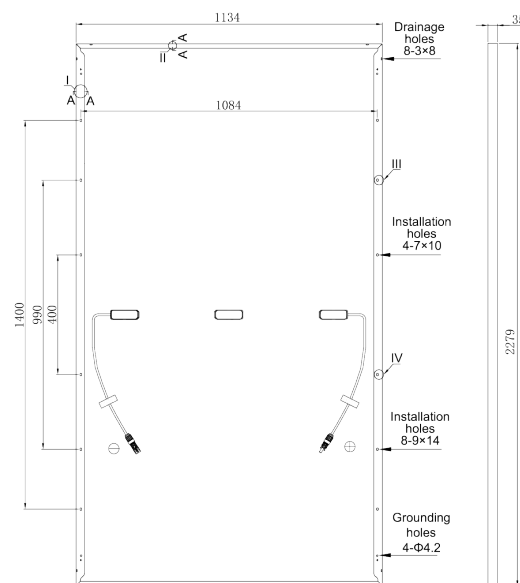

SECTION A-A I

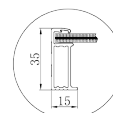

SECTION A-A II

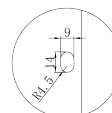

Enlarge figure III

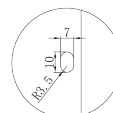

Enlarge figure IV



**Warning:** Read the Installation and User Manual in its entirety before handling, installing and operating Yingli Solar modules.



# YLM-J 3.0 PRO 530-555 W

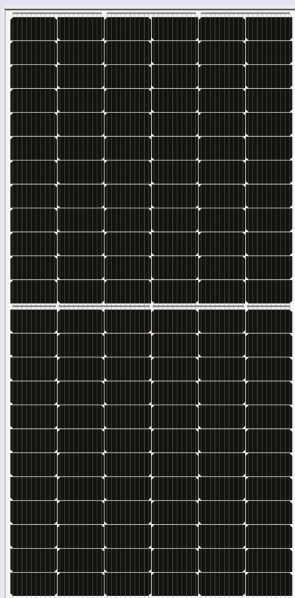

144 CELL  
CELL QUANTITY

0-5 W  
POWER TOLERANCE

12 YEAR  
PRODUCT WARRANTY

25 YEAR  
POWER WARRANTY

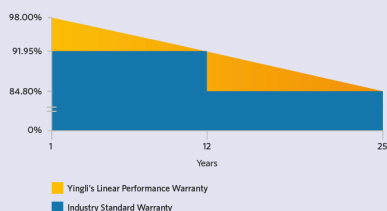

# IMPROVED POWER NEVER SETTLE FOR LESS

YLM 3.0 modules use high efficiency p-type monocrystalline PERC cell technology. With high quality encapsulation materials and classic glass-backsheet structure, YLM 3.0 modules are perfectly suited to the harsh environment and provide you with high reliability and quality assurance.



### Classic Structure

The glass-backsheet structure and layout design have been proven in the market for a long time.



### Superior Yield

The large size cell enhances the module's power output, while the excellent temperature coefficient and comprehensive LID/LeTID degradation suppression technology allow the module to generate more energy yield once in use.



### Excellent Durability

The modules meet IEC standard testing requirements and are resistant to salt mist, ammonia, dust and sand, snail trail and PID risks.



### Wide Applications

The glass-backsheet structure, special material selection and extra-strong frames effectively enhance the mechanical performance of the modules, their compatibility with mainstream trackers and inverters, and their adaptability to harsh environments.



### Lower Losses

The multi-busbar design effectively reduces the impact of micro-cracks and broken busbars, and the half-cell structure effectively reduces the impact of shadow shading.

## QUALIFICATIONS & CERTIFICATES

IEC 61215, IEC 61730, CE, UL 61730



### Yingli Solar

Headquartered in Baoding, China, Yingli Energy Development Company Limited, known as Yingli Solar, is a leading solar solution provider. Yingli Solar is committed to providing clean, renewable energy through PV power generation technology for factories, homes and utilities around the world. Yingli Solar provides reliable products and services through continuous technological advancement and management innovation.

# YLM-J 3.0 PRO

## Electrical parameters at Standard Test Conditions (STC)\*

Module type			YLxxxD-49e 1/2 (xxx=Pmax)					
			YLxxxD-49e 1500V 1/2 (xxx=Pmax)					
Power output	$P_{max}$	W	530	535	540	545	550	555
Power output tolerances	$\Delta P_{max}$	W	0 / + 5					
Module efficiency	$\eta_m$	%	20.51	20.70	20.89	21.09	21.28	21.48
Voltage at $P_{max}$	$V_{mpp}$	V	41.40	41.55	41.70	41.85	42.00	42.15
Current at $P_{max}$	$I_{mpp}$	A	12.81	12.88	12.95	13.03	13.10	13.17
Open-circuit voltage	$V_{oc}$	V	49.22	49.37	49.52	49.67	49.82	49.97
Short-circuit current	$I_{sc}$	A	13.69	13.76	13.83	13.90	13.97	14.04

\*STC: 1000 W·m<sup>-2</sup> irradiance, 25°C cell temperature, AM 1.5 spectrum according to EN 60904-3.

## Electrical parameters at Nominal Operating Cell Temperature (NOCT)\*

Power output	$P_{max}$	W	394.32	398.04	401.76	405.48	409.20	412.92
Voltage at $P_{max}$	$V_{mpp}$	V	38.48	38.63	38.78	38.90	39.05	39.19
Current at $P_{max}$	$I_{mpp}$	A	10.25	10.30	10.36	10.42	10.48	10.54
Open-circuit voltage	$V_{oc}$	V	46.10	46.24	46.38	46.52	46.66	46.80
Short-circuit current	$I_{sc}$	A	11.06	11.12	11.17	11.23	11.29	11.34

\*NOCT: open-circuit module operation temperature at 800 W·m<sup>-2</sup> irradiance, 20°C ambient temperature, 1 m·s<sup>-1</sup> wind speed.

## THERMAL CHARACTERISTICS

Nominal operating cell temperature	NOCT	°C	45 ± 2	
Temperature coefficient of $P_{max}$	$\gamma$	%/°C	- 0.35	
Temperature coefficient of $V_{oc}$	$\beta$	%/°C	- 0.27	
Temperature coefficient of $I_{sc}$	$\alpha$	%/°C	0.05	

## OPERATING CONDITIONS

Max. system voltage	1000 V <sub>DC</sub> / 1500 V <sub>DC</sub>	
Max. series fuse rating*	25 A	
Operating temperature range	- 40°C to 85°C	
Max. static load, front (e.g., snow)	5400 Pa	
Max. static load, back (e.g., wind)	2400 Pa	
Max. hailstone impact (diameter / velocity)	25 mm / 23 m·s <sup>-1</sup>	

\*DO NOT CONNECT FUSE IN COMBINER BOX WITH TWO OR MORE STRINGS IN PARALLEL CONNECTION.

## CONSTRUCTION MATERIALS

Cell ( material / quantity )	p-type monocrystalline silicon / 6 x 24
Glass (material / thickness)	low-iron tempered glass / 3.2 mm
Frame (material )	anodized aluminum alloy
Junction box (type / protection degree)	3 bypass diodes / ≥ IP67
Cable (length / cross-sectional area)	± 300 mm or customized length / 4 mm <sup>2</sup>

## GENERAL CHARACTERISTICS

Dimensions (L / W / H)	2279 mm / 1134 mm / 30 mm
Weight	28.2 kg

## PACKAGING SPECIFICATIONS

Number of modules per pallet	36
Number of pallets per 40' container	20
Packaging box dimensions (L / W / H)	2300 mm / 1110 mm / 1245 mm
Box weight	1070 kg

Unit: mm

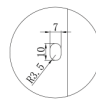
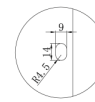
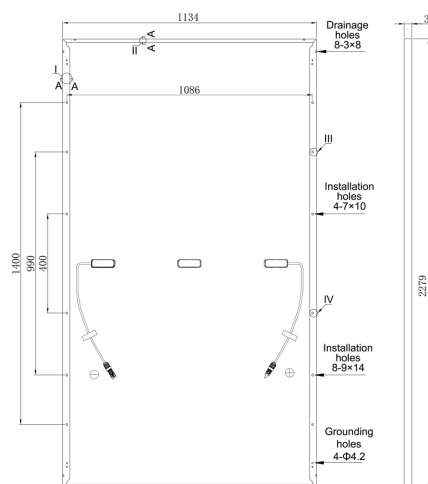

**Warning:** Read the Installation and User Manual in its entirety before handling, installing and operating Yingli Solar modules.

- Due to continuous innovation, research and product improvement, the specifications in this product information sheet are subject to change without prior notice. The specifications may deviate slightly and are not guaranteed.
- The data do not refer to a single module and they are not part of the offer, they only serve for comparison to different module types.

## YLM 3.0 PLUS 580-605 W

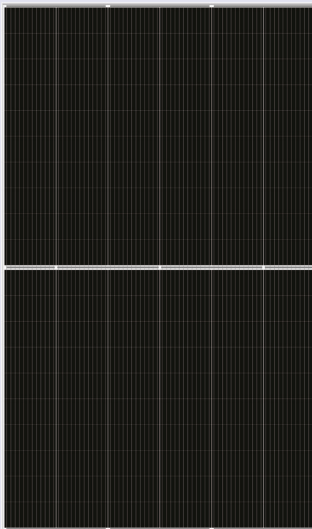

120 CELL  
CELL QUANTITY

0-5 W  
POWER TOLERANCE

12 YEAR  
PRODUCT WARRANTY

25 YEAR  
POWER WARRANTY

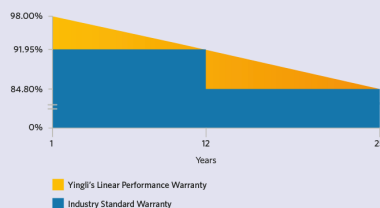

# IMPROVED POWER NEVER SETTLE FOR LESS

YLM 3.0 modules use high efficiency p-type monocrystalline PERC cell technology. With high quality encapsulation materials and classic glass-backsheet structure, YLM 3.0 modules are perfectly suited to the harsh environment and provide you with high reliability and quality assurance.



### Classic Structure

The glass-backsheet structure and layout design have been proven in the market for a long time.



### Superior Yield

The large size cell enhances the module's power output, while the excellent temperature coefficient and comprehensive LID/LeTID degradation suppression technology allow the module to generate more energy yield once in use.



### Excellent Durability

The modules meet IEC standard testing requirements and are resistant to salt mist, ammonia, dust and sand, snail trail and PID risks.



### Wide Applications

The glass-backsheet structure, special material selection and extra-strong frames effectively enhance the mechanical performance of the modules, their compatibility with mainstream trackers and inverters, and their adaptability to harsh environments.



### Lower Losses

The multi-busbar design effectively reduces the impact of micro-cracks and broken busbars, and the half-cell structure effectively reduces the impact of shadow shading.

## QUALIFICATIONS & CERTIFICATES

IEC 61215, IEC 61730, CE



### Yingli Solar

Headquartered in Baoding, China, Yingli Energy Development Company Limited, known as Yingli Solar, is a leading solar solution provider. Yingli Solar is committed to providing clean, renewable energy through PV power generation technology for factories, homes and utilities around the world. Yingli Solar provides reliable products and services through continuous technological advancement and management innovation.

# YLM 3.0 PLUS

## Electrical parameters at Standard Test Conditions (STC)\*

Module type			YLxxxD-41f 1/2 (xxx=Pmax) YLxxxD-41f 1500V 1/2 (xxx=Pmax)					
Power output	$P_{max}$	W	580	585	590	595	600	605
Power output tolerances	$\Delta P_{max}$	W	0 / + 5					
Module efficiency	$\eta_m$	%	20.49	20.67	20.85	21.02	21.20	21.38
Voltage at $P_{max}$	$V_{mpp}$	V	33.80	34.00	34.20	34.40	34.60	34.80
Current at $P_{max}$	$I_{mpp}$	A	17.16	17.21	17.25	17.30	17.34	17.39
Open-circuit voltage	$V_{oc}$	V	40.80	41.00	41.20	41.40	41.60	41.80
Short-circuit current	$I_{sc}$	A	18.21	18.26	18.31	18.36	18.42	18.48

\*STC: 1000 W·m<sup>-2</sup> irradiance, 25°C cell temperature, AM 1.5 spectrum according to EN 60904-3.

## Electrical parameters at Nominal Operating Cell Temperature (NOCT)\*

Power output	$P_{max}$	W	435.60	439.36	443.11	446.87	450.62	454.38
Voltage at $P_{max}$	$V_{mpp}$	V	31.73	31.91	32.11	32.29	32.48	32.66
Current at $P_{max}$	$I_{mpp}$	A	13.73	13.77	13.80	13.84	13.87	13.91
Open-circuit voltage	$V_{oc}$	V	37.92	38.11	38.29	38.48	38.66	38.85
Short-circuit current	$I_{sc}$	A	14.67	14.71	14.75	14.79	14.84	14.89

\*NOCT: open-circuit module operation temperature at 800 W·m<sup>-2</sup> irradiance, 20°C ambient temperature, 1 m·s<sup>-1</sup> wind speed.

## THERMAL CHARACTERISTICS

Nominal operating cell temperature	NOCT	°C	43 ± 2
Temperature coefficient of $P_{max}$	$\gamma$	%/°C	- 0.34
Temperature coefficient of $V_{oc}$	$\beta$	%/°C	- 0.25
Temperature coefficient of $I_{sc}$	$\alpha$	%/°C	0.04

## OPERATING CONDITIONS

Max. system voltage	1000 V <sub>DC</sub> / 1500 V <sub>DC</sub>
Max. series fuse rating*	30 A
Operating temperature range	- 40°C to 85°C
Max. static load, front (e.g., snow)	5400 Pa
Max. static load, back (e.g., wind)	2400 Pa
Max. hailstone impact (diameter / velocity)	25 mm / 23 m·s <sup>-1</sup>

\* DO NOT CONNECT FUSE IN COMBINER BOX WITH TWO OR MORE STRINGS IN PARALLEL CONNECTION.

## CONSTRUCTION MATERIALS

Cell (material / quantity)	p-type monocrystalline silicon / 6 x 20
Glass (material / thickness)	low-iron tempered glass / 3.2 mm
Frame (material)	anodized aluminum alloy
Junction box (type / protection degree)	3 bypass diodes / ≥ IP67
Cable (length / cross-sectional area)	± 300 mm or customized length / 4 mm <sup>2</sup>

## GENERAL CHARACTERISTICS

Dimensions (L / W / H)	2172 mm / 1303 mm / 35 mm
Weight	31 kg

## PACKAGING SPECIFICATIONS

Number of modules per pallet	31
Number of pallets per 40' container	17
Packaging box dimensions (L / W / H)	1340 mm / 1140 mm / 2290 mm
Box weight	1013 kg

Unit: mm

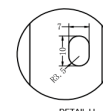
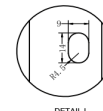
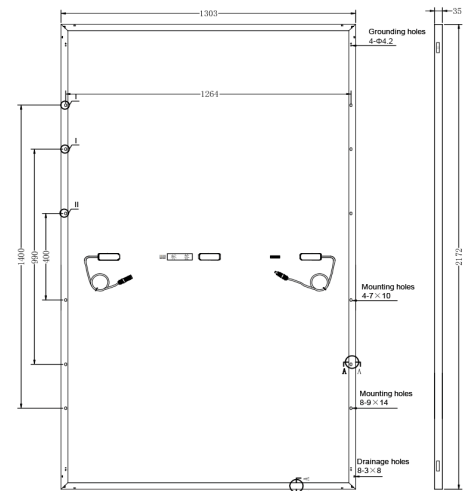

**Warning:** Read the Installation and User Manual in its entirety before handling, installing and operating Yingli Solar modules.

- Due to continuous innovation, research and product improvement, the specifications in this product information sheet are subject to change without prior notice. The specifications may deviate slightly and are not guaranteed.
- The data do not refer to a single module and they are not part of the offer, they only serve for comparison to different module types.



## TEANA WATER HEATER

### CELENTADOR DE AGUA HÍBRIDO

30G1.3 | 60G1.3

*Agua caliente con una temperatura estable, buena presión, bajo consumo de energía y modo de funcionamiento híbrido solar DC y AC.*



- *Conexión directa a paneles fotovoltaicos (PVDC), no requiere inversor.*
- *Entrada independiente en AC para conexión a la red pública.*
- *Calentamiento independiente, para AC (red o PVAC) y PVDC.*
- *Control de temperatura mediante micro-controlador.*
- *Pantalla digital que indica temperatura.*
- *Válvula de drenaje instalada.*
- *Tanque y base en acero inoxidable, no requiere ánodo de sacrificio.*
- *Aislamiento en poliuretano sin HFCs de 55 mm.*
- *Cubierta exterior en lámina de acero y pintura resistentes al agua.*
- *Conectividad WIFI con almacenamiento de datos en la nube y monitoreo.*
- *10 años de garantía en tanque.*

ESPECIFICACIONES	UNIDADES	30 Galones	60 Galones
<b>Calentador de agua TEANA</b>			
Nombre del producto		TEANA 30G1.3	TEANA 60G1.3
Capacidad	l	114	228
Potencia de calentamiento máx. resistencia AC	W	1500	3000
Potencia de calentamiento máx. resistencia DC	W	2000	4000
Presión Nominal	MPa (psi)	0.69 (100)	0.69 (100)
Peso bruto	kg	85	100
Máxima temperatura del agua dentro del tanque	°C	88	88
Rango ajustable de temperatura del agua	°C	25-88	25-88
Protección de polaridad inversa integrado		Si	Si
Display Digital		Si	Si
Conexión de respaldo a la red		Si	Si
Tanque de agua en acero inoxidable		Si	Si
Dimensiones (largo, ancho, alto)	cm	47x47x155	56x56x191
Conexión tuberías de agua	NPT	½"	½"
Válvula de alivio de presión y temperatura integrada		No incluida	No incluida

### Alimentación de la Red

Tensión nominal	V	120	120
Consumo de corriente máxima	A	14	28

### Alimentación Fotovoltaica

Potencia PV recomendada	$W_p$	1500-2000	3000-4000
Potencia PV máxima	$W_p$	2400	4800
Corriente máxima	A	30	60
Voltaje de Circuito abierto máx. a 25° C	$V_{dc}$	110	110
Conector (cable) PV		MC4	MC4
Cable Solar		6 mm <sup>2</sup>	10 mm <sup>2</sup>

**Todas las especificaciones pueden cambiar sin previo aviso.**

**Advertencia:** La instalación se debe hacer cumpliendo las normativas vigentes. Refiérase a la norma NTC 888.

**Precaución:** La temperatura máxima del agua caliente recomendada para uso residencial es de 48° C. Teana recomienda la instalación de una válvula de mezclado termostática o una válvula anti quemaduras, y su uso siguiendo las recomendaciones del respectivo fabricante.

**Presiones:** Presión de trabajo, 100 psi; Presión de prueba hidrostática, 150 psi.

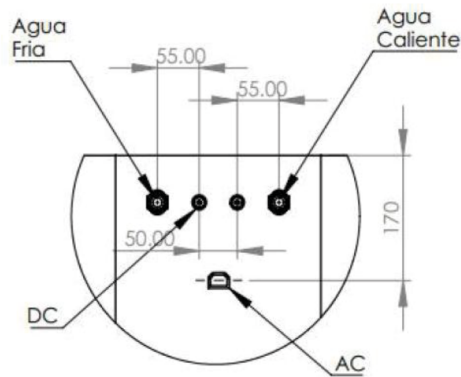
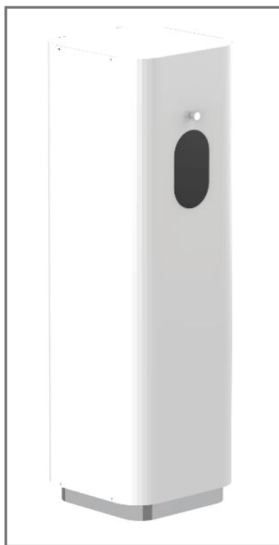
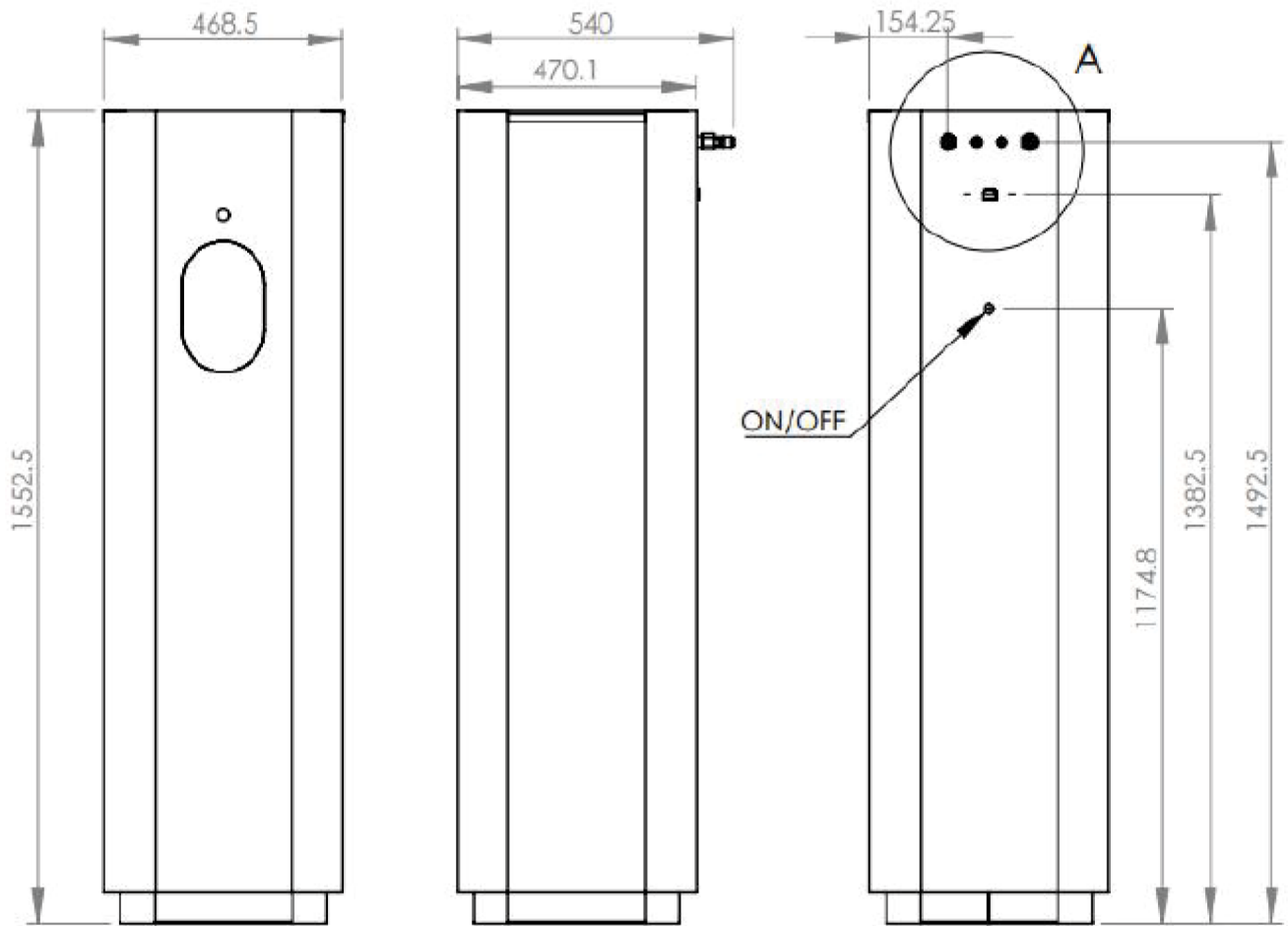

DETAIL A  
SCALE 1 : 10

TEANA WATER HEATER  
30 GL

Plano de Ensamble  
Escala 1:20  
Unidades: mm

# ESTRUCTURA SOLAR STACK PARA TECHOS PLANOS E INCLINADOS

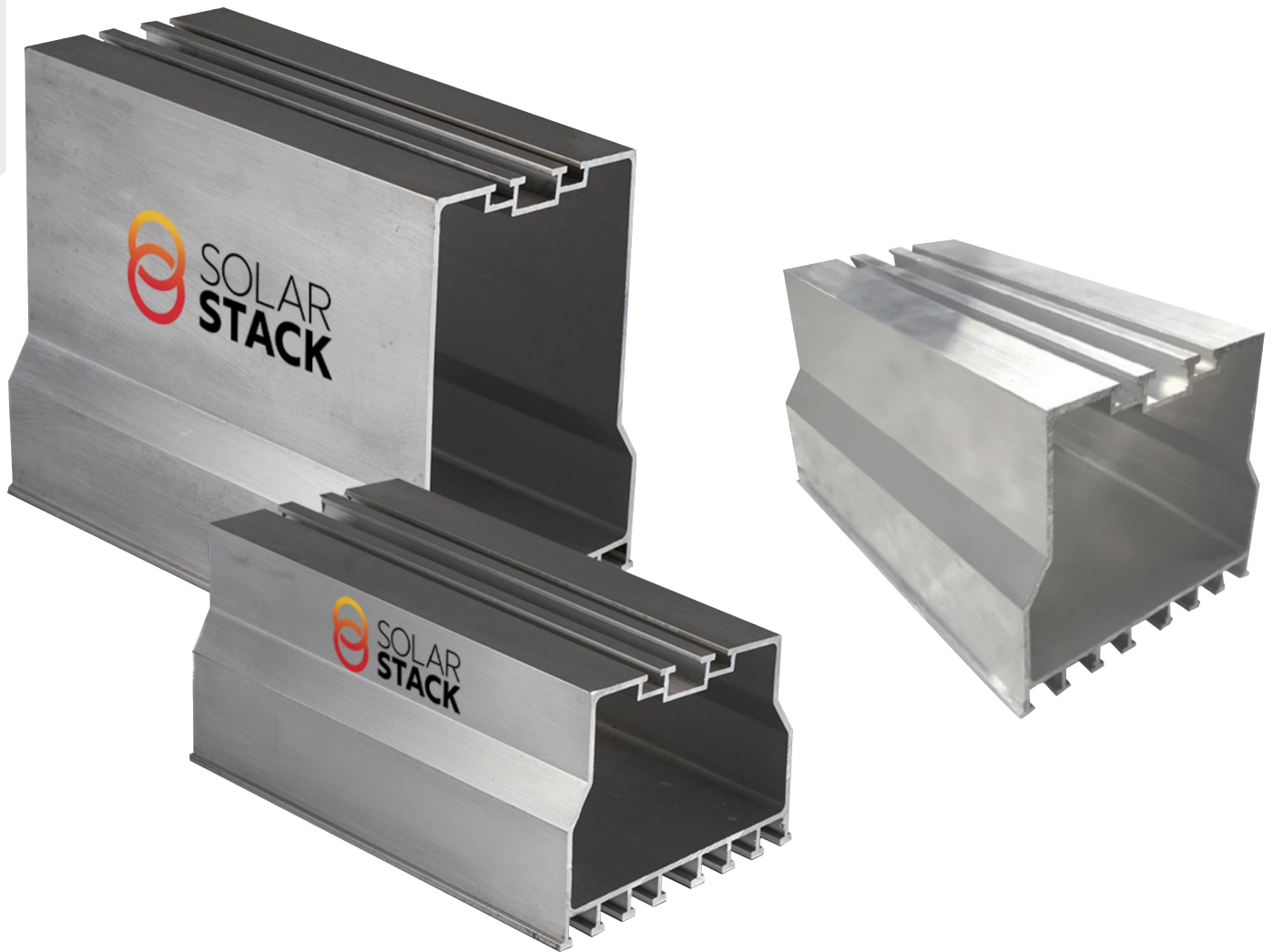

Solar Stack es un pedestal único e innovador que monta paneles solares en los techos con un adhesivo de espuma aprobado por el código. Solar Stack es el único sistema de montaje de paneles solares que promete CERO penetraciones en el techo y cumple con los códigos de viento más estrictos de los Estados Unidos.



## SOLAR STACK'S COMPONENTS

- Suitable for residential and commercial projects
- Parallel to roof – suitable for pitched and flat roofs
- 8" – 12" Length of the SS pedestals (mounts)
- Solar modules can be mount in Portrait or Landscape orientation

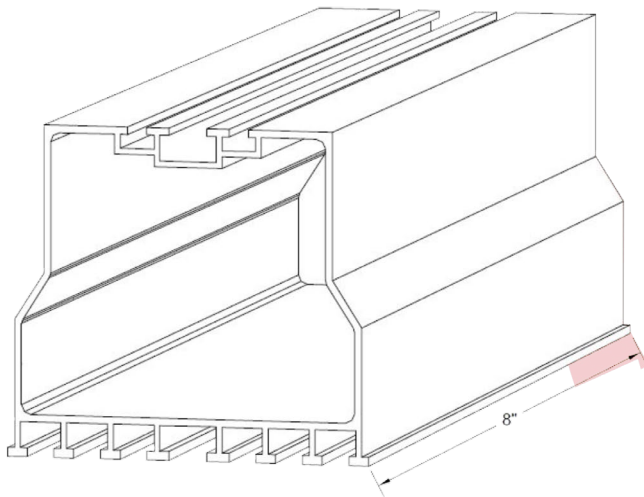

## SOLAR STACK'S COMPONENTS

- Suitable mainly for commercial projects
- Modules can be mount in Landscape orientation only!
- 5 degree tilt– suitable for FLAT roofs
- 8" or 12" Length

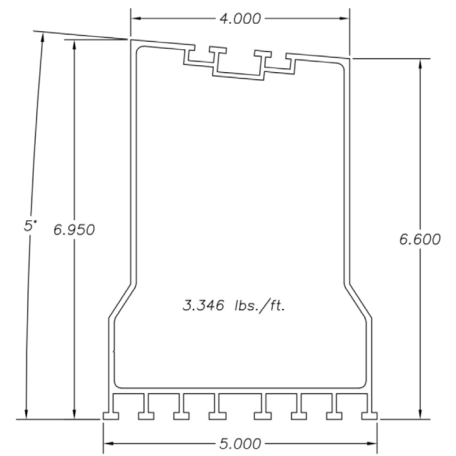
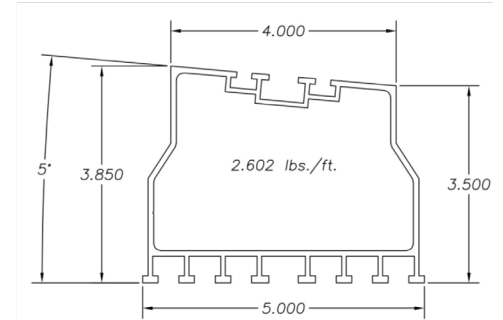

## INSTALLING SOLAR STACK PEDESTALS

Determine the spacing of Solar Stack pedestals for your solar array design. Surface Preparation. All roof surfaces must be free of any debris, dirt, grease, oil, and standing water before adhesive is applied. Follow adhesive manufacturers application instructions.

Approved adhesive types used for installation of Solar Stack pedestals are located in the following table.

Uplift Load applied to the Top of "SOLAR STACK GEN 3" or "DOUBLE DOWN GEN 3" Assembly (90° To Roof Surface)				
Adhesive Type:	GEN 3 Pedestal Size:	Paddy Dimensions:	Paddy Weight:	Ultimate Load <sup>1</sup> :
ICP Polyset® AH-160	12"	16-5/8" x 8-7/8"	79.9 grams	-833 LBF
ICP Polyset® AH-160	8"	12-3/8" x 8"	62.6 grams	-658 LBF
DOW Tile Bond	8"	10-1/2" x 7"	55 grams	-383 LBF
DOW Insta-Stik	8"	10-1/2" x 7"	59.8 grams	-400 LBF
DAP Stormbond	8"	10-1/2" x 7"	52.1 grams	-500 LBF

Notes:  
 1. Ultimate Loads with 0 margin of safety applied to the test loads.  
 2. Assembly was tested for vertical up.

Table 7-1 (Evaluation report for Florida product approval #FL 21074.6 R4)

We strongly recommend that all the installers should have training for proper use of the foam adhesive before they do any installation of the Solar Stacks.

It is very important to use approved foam adhesives only. For proper use of the foam adhesive, manufacturer installation instructions must be followed.



# TECHNICAL DATA SHEET

POLYSET® AH-160



## LOW PRESSURE POLYURETHANE FOAM INFORMATION

<b>Description</b>	Low pressure, two-component spray polyurethane foam adhesive
<b>SPF</b>	Spray Polyurethane Foam
<b>Applications</b>	Designed to adhere to concrete and clay roof tile onto compatible roofing underlayment surfaces.
<b>Preparation for use</b>	Substrate must be clean, dry, firm, free of loose particles, and free of dust, grease and mold release agents. Protect surfaces not to be foamed. Read SDS, Operating Instructions, and Product Stewardship Guidelines. For additional information go to <a href="http://www.icpadhesives.com">www.icpadhesives.com</a> .
<b>Use</b>	Warm/Cool chemical to 70-90 F (21-32 C). Follow instructions for set-up found in the operating instructions.
<b>PPE</b>	 <p>Wear protective glasses with side shields or goggles, nitrile gloves, and clothing that protects against dermal exposure. Recommend dispensing product in a well-ventilated area with certified respiratory protection; however, well ventilated exterior applications may not need respiratory protection. It is the responsibility of the employer to complete a PPE evaluation and/or exposure assessment to determine if respiratory protection is required. Read all instructions, ICP Product Stewardship Guidelines, and SDS (Section 8) prior to use of any product.</p>
<b>Note</b>	FOR PROFESSIONAL USE ONLY. Always check the local building code before use. Cured low pressure polyurethane foam is non-toxic and inert.
<b>Temperature</b>	Please see chart located on page 2
<b>Product Storage</b>	Store in a dry area. Optimum chemical storage temperature is 50-100°F (10-38°C). Excessive heat can cause premature aging of components resulting in a shorter shelf-life. Do not allow material to freeze.
<b>Disposal</b>	Refer to SDS (Section 13) for instructions. Always dispose of empty cylinders in according to applicable federal, state, provincial and local regulations.
<b>Shelf-life</b>	12 months
<b>Compatibility</b>	Cured low pressure polyurethane foam is chemically inert and non-reactive in approved applications. Compatible with structural concrete, asphalt primed concrete, and insulating concrete, various BUR, base sheets, steel-22 gauge or lower, vapor retarders, gypsum, polystyrene, wood fiber, and polyisocyanurate.
<b>Limitations</b>	Do not use when ambient substrate temperatures are below 40°F (4°C). Do not use during inclement weather, on wet surfaces or on any roof deck showing signs of deterioration or loss of structural integrity. Do not use after the expiration date.
<b>Additional Attachment Requirement</b>	Additional fastening may be necessary on steep pitches. Reference installation instructions on <a href="http://www.icpadhesives.com">www.icpadhesives.com</a> .
<b>Tile Profile</b>	See chart located on Page 3.

TECHNICAL DATA	STANDARD	RESULTS
<b>Density</b>	ASTM D1622	1.6 lbs/ft <sup>3</sup> (25.6 kg/m <sup>3</sup> )
<b>Compressive Strength</b>	ASTM D1623	18 lbf/in <sup>2</sup> (124 kPa) Parallel 12 lbf/in <sup>2</sup> (82 kPa) Perpendicular
<b>Tensile Strength</b>	ASTM D412	28 psi
<b>Water Absorption</b>	ASTM D2842	3.73%
<b>Moisture Vapor Transmission</b>	ASTM E96	3.1 Perm-in
<b>Dimensional Stability</b>	ASTM D2126	At -40 F (4 C) +0.07% At 158 F (70 C) +6.0%
<b>Closed Cell Content</b>	ASTM 2856	86%



POLYSET® AH-160

**APPROVALS/STANDARDS/CLASSIFICATIONS**

**Class A Rated, ASTM E108**

**Florida Product Approval** FBC Approved FL6276-R5

**Miami Dade NOA** 17-0322.03



**TEMPERATURE GUIDELINES**

<b>Chemical Storage Temperature</b>	50-100 F (10-38°C)
<b>Outside Application Temperature</b>	40-100 F (4-38°C)
<b>Process Core Chemical Temperature</b>	70-90 F (21-32°C)
<b>Surface Temperature (Substrate)</b>	40-100 F (4-38°C)

**PROPERTIES AND YIELD<sup>1</sup>**

	<b>Weight</b> (Including packaging)	<b>Coverage</b> (30-gram medium paddy)	<b>Open Time</b>	<b>Work Life in Mixing Nozzle</b>	<b>Set-up Time</b>	<b>Time to Full Cure</b>
<b>62496580302</b>	45.3 lbs / A component 40 lbs / B component	1295	1 – 2 minutes <sup>1</sup>	1 minute <sup>1</sup>	10 – 20 minutes <sup>1</sup>	24 - 48 hours
<b>62000180302</b>	14 lbs / A component 12.5 lbs / B component	400	1 – 2 minutes <sup>1</sup>	1 minute <sup>1</sup>	10 – 20 minutes <sup>1</sup>	24 - 48 hours

<sup>1</sup>Times may be affected by temperature and weather conditions.

**ADHESIVE PLACEMENT FOR TILE PROFILE\***

<b>Tile Profile</b>	<b>Minimum Paddy Contact Area</b>	<b>Minimum Paddy Gram Weight</b>
Flat Low High	17-23 sq inches	45-65
Flat	10-12 sq inches	30
Low	12-14 sq inches	30
High	17-19 sq inches	30
Flat Low High	Two Paddys: 8-9 sq inches at head of tile 9-11 sq inches at overlap	12 grams per paddy
Two-Piece Barrel (Cap Tile)	2 beads (1 each longitudinal edge) 20-25 sq inches each bead	17 grams per paddy
Two Piece Barrel (Pan Tile)	65-70 sq inches	34 grams under pan

\*See NOA No.: 17-0322.03 for tile placement illustrations.

### FEMALE AND MALE CABLE COUPLER MC4

Female and male cable coupler as individual part (including insulating part)



PV-KBT4...



PV-KST4...



### FEMALE AND MALE PANEL RECEPTACLE MC4

Female and male panel receptacles as individual part (including insulating part)



PV-ADBP4-S2...



## S800PV-S MINIATURE CIRCUIT BREAKERS AN S800PV-M SWITCH-DISCONNECTORS



Diseñado para desconectar la alimentación en la corriente continua proveniente de los paneles solares, y así garantizar el aislamiento del inversor para su mantenimiento. Grado de protección IP65 ideal para uso exterior

## E 90 PV FUSE HOLDERS FOR PHOTOVOLTAIC APPLICATIONS

Designed for industry professionals



Los portafusibles FEEO, por su tamaño y precio, representan la mejor alternativa para instalaciones solares residenciales y comerciales. Disponibles en modelos de 1 Portafusible para protección de tus cadenas fotovoltaicas.

## OVR PV SURGE PROTECTION DEVICES



Dispositivos de protección en DC contra sobre tensiones y rayos eléctricos que protegen los inversores contra aumentos de voltaje en la instalación.

## OT SWITCH-DISCONNECTORS



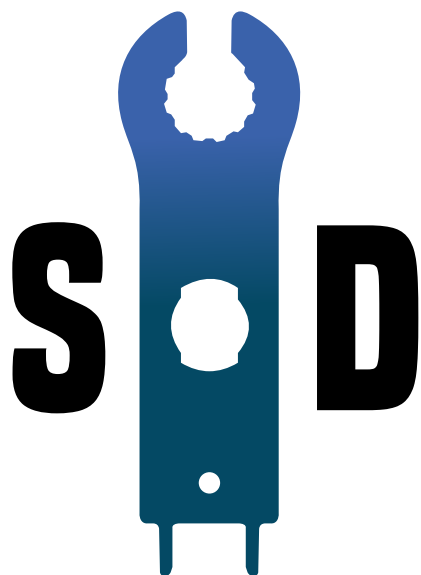

# DESCARGA NUESTRO CATÁLOGO

Obtén la versión digital de nuestro catálogo scaneando este código QR.

